



**International  
FX and VFX Series  
INVERTER/CHARGER  
Programming Manual**

## WARRANTY SUMMARY

Dear OutBack Customer,

Thank you for your purchase of OutBack products. We make every effort to assure our power conversion products will give you long and reliable service for your renewable energy system.

As with any manufactured device, repairs might be needed due to damage, inappropriate use, or unintentional defect. Please note the following guidelines regarding warranty service of OutBack products:

- Any and all warranty repairs must conform to the terms of the warranty.
- All OutBack equipment must be installed according to their accompanying instructions and manuals with specified over-current protection in order to maintain their warranties.
- The customer must return the component(s) to OutBack, securely packaged, properly addressed, and shipping paid. We recommend insuring your package when shipping. Packages that are not securely packaged can sustain additional damage not covered by the warranty or can void warranty repairs.
- There is no allowance or reimbursement for an installer's or user's labor or travel time required to disconnect, service, or reinstall the damaged component(s).
- OutBack will ship the repaired or replacement component(s) prepaid to addresses in the continental United States, where applicable. Shipments outside the U.S. will be sent freight collect.
- In the event of a product malfunction, OutBack cannot bear any responsibility for consequential losses, expenses, or damage to other components.
- Please read the full warranty at the end of this manual for more information.

### About Outback Power Systems

OutBack Power Systems is a leader in advanced energy conversion technology. Our products include true sine wave inverterchargers, maximum power point charge controllers, system communication components, as well as breaker panels, breakers, accessories, and assembled systems.

### Notice of Copyright

International FX and VFX Series Inverter/Charger Programming Manual © 2007 All rights reserved.

### Disclaimer

UNLESS SPECIFICALLY AGREED TO IN WRITING, OUTBACK POWER SYSTEMS:

(a) MAKES NO WARRANTY AS TO THE ACCURACY, SUFFICIENCY OR SUITABILITY OF ANY TECHNICAL OR OTHER INFORMATION PROVIDED IN ITS MANUALS OR OTHER DOCUMENTATION.

(b) ASSUMES NO RESPONSIBILITY OR LIABILITY FOR LOSS OR DAMAGE, WHETHER DIRECT, INDIRECT, CONSEQUENTIAL OR INCIDENTAL, WHICH MIGHT ARISE OUT OF THE USE OF SUCH INFORMATION. THE USE OF ANY SUCH INFORMATION WILL BE ENTIRELY AT THE USER'S RISK.

### Contact Information:

OutBack Power Systems

19009 62nd Ave. NE

Arlington, WA 98223 Phone (360)435-6030 • Fax (360)435-6019    [www.outbackpower.com](http://www.outbackpower.com)

Date and Revision • July 2008 REV C

# TABLE OF CONTENTS

Warranty Summary.....	1
Declaration of Conformity .....	3
Welcome to the OutBack Power Systems FX Series Inverter/Charger System .....	4
Safety.....	4
Modes and Properties .....	5
Set-Up Screens.....	5
Search Mode .....	6
Input Menu .....	7
Advanced Screens .....	9
Inverter Menu .....	10
Charger Menu.....	13
Generator Menu.....	16
FX Series Inverter/Charger Programming .....	19
Components and Connections.....	20
Stacking Options .....	23
OutBack Parallel.....	23
3-Phase .....	24
Stacking And Assigning FX Status .....	24
1-2ph Master.....	24
Classic Slave.....	25
OB Slave L1 .....	25
3ph Master.....	25
3ph Slave.....	25
Programming the FXs.....	26
1-2 ph Master.....	29
OutBack (OB) Slave.....	29
OutBack (OB) Slave 2.....	30
3-Phase (3ph) Master .....	30
3-Phase (3-ph) Slave .....	31
Introduction to Power Save Levels.....	32
Powering Up.....	34
Stacking System Examples .....	36
OutBack Parallel Stacking.....	36
Ranking the Slaves .....	37
3-Phase Stacking .....	39
Auxiliary (AUX) Functions .....	40
List of AUX Functions.....	43
Adjustable AUX Output Functions.....	43
Battery Charging Function .....	46
Maintenance .....	46
Battery Charging Instructions.....	47
FX Default Values .....	50
Warranty.....	51
Product Registration.....	53

## DECLARATION OF CONFORMITY

The OutBack Power Systems FX Series Inverter/Chargers export (“E”) models comply with the EU Declaration of Conformity regarding Electromagnetic Compatibility 89/336/EEC (“Council Directive of 3 May 1989”) and Low Voltage Directive 73/23/EEC (“Council Directive of 19 February 1973”) when installed in off-grid applications only. These inverter/chargers are not to be connected to the mains under any circumstances.

The AC-IN connection on each E model inverter/charger is only approved for connection to an AC generator.

FX Series Inverter/Chargers covered by the EU Declaration of Conformity:

- FX2012ET
- FX2024ET
- FX2348ET
- VFX2612E
- VFX3024E
- VFX3048E

## WELCOME TO THE OUTBACK POWER SYSTEMS FX SERIES INVERTER/CHARGER SYSTEM

The FX and VFX Series Inverter/Charger offers a complete power conversion system—DC to AC, battery charging, and an AC internal transfer relay—for stand-alone applications.

OutBack Power Systems does everything possible to assure the components you purchase will function properly and safely when installed as instructed according to local and national electrical codes. Please read all of the following instructions and the instructions that come with any OutBack components included in your power system. Further instructions on individual FX set-ups as well as systems assemblies are included with the *International FX and VFX Series Inverter/Charger Installation Manual*.

The OutBack Power Systems FX and VFX is ETL listed to UL1741 (Inverters, Converters, Controllers, and Interconnection System Equipment for Use with Distributed Energy Resources). All Mobile FX Series Inverter/Chargers are ETL listed to UL 458.

### Grounding Instructions

Each FX should be connected to a grounded, permanent wiring system. For most installations, the negative battery conductor should be bonded to the grounding system at one (and only one) point in the DC system. All installations must comply with all national and local codes and ordinances.

The equipment ground is marked with this symbol: 

The *International FX and VFX Series Inverter/Charger Programming Manual* covers the following information:

- Safety
- Programming or “stacking” multiple FXs using the OutBack Power Systems MATE
- Explaining the FX modes and properties.

## IMPORTANT SAFETY INSTRUCTIONS KEEP THESE INSTRUCTIONS

### General Precautions

1. Use caution whenever working around electricity, electrical components, and batteries. There is always a potential for shocks, burns, injury, and even death if an installer or user comes in contact with electricity.
2. Read all instructions and cautionary markings on the FX, the batteries and all appropriate sections of this manual as well as other component manuals before using the system.
3. Be sure each system FX is securely installed according to the *International FX and VFX Series Inverter/Charger Installation Manual*.
4. Follow all local and national electrical codes when installing OutBack equipment and components.

## FX MODES AND PROPERTIES

Each OutBack FX and VFX comes with various default values set at the factory. Typically, a single FX installation will retain these values, but multiple FXs will require programming using the OutBack MATE. Viewing the status of an FX and adjusting its functions also requires a MATE.



MATE

The OutBack MATE is a system controller and display which shows operational status via a lighted screen. It allows a user to change function settings such as battery charging and generator usage using a series of buttons (“soft” keys and “hot” keys).

## SETUP SCREENS

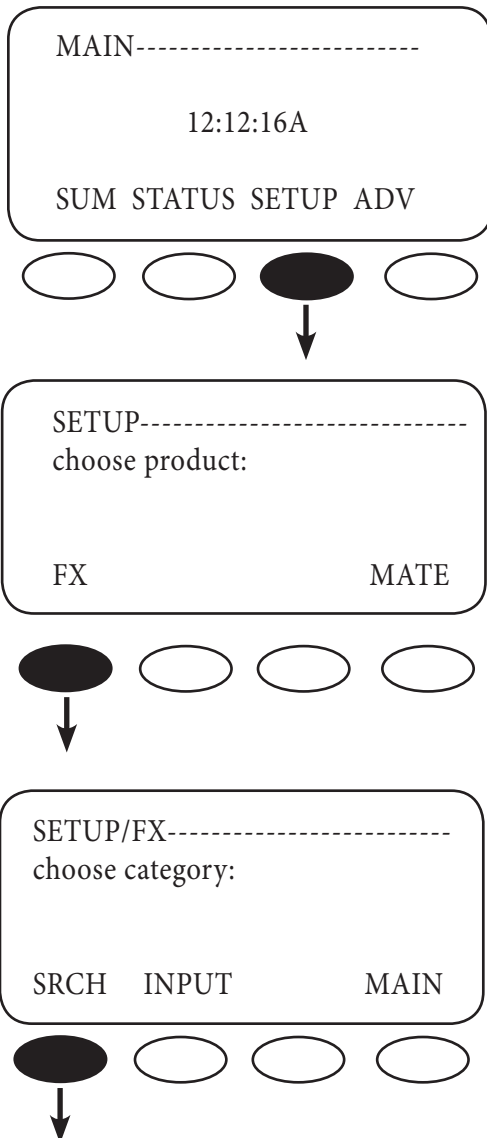

From the MAIN screen, press **SETUP**

**NOTE:** Pressing and holding the first two soft keys at the same time will always bring up the MAIN Menu screen. The *SUM* and *STATUS* screens are displayed and explained in the *MATE Installation and User Manual*.

Press **FX**

Two choices are available in the choose category screen:

- Search (SRCH) which adjusts the search mode settings
- INPUT which for selecting the AC INPUT and current limit adjustment

Press **SRCH** to open the search screens.

## SEARCH MODE

An FX consumes a small amount of power when it is not providing AC to loads or recharging batteries. In SEARCH MODE, the FX is inactive and conserves power until it senses a user-determined size load. The FX then turns on to provide AC to that load. The SEARCH features are mainly used in off-grid systems to conserve power.

**NOTE:** Some loads will require experimenting with the SEARCH settings and other loads, such as fluorescent lights with magnetic ballasts, might not work well at all.

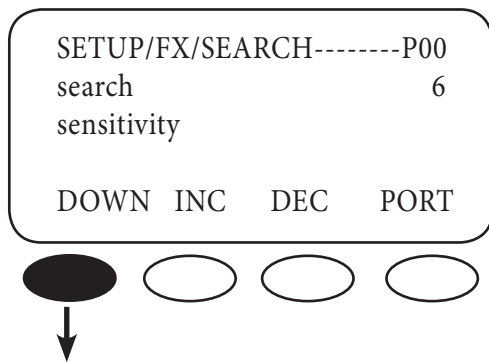

Use the *search sensitivity* screen to determine the size of an AC load needed for the FX to turn ON and leave SEARCH mode.

- Pressing **INC** decreases sensitivity (a bigger load is needed to turn the FX on)
- Pressing **DEC** increases the sensitivity which means a smaller load (less wattage) will turn the FX on
- Decreasing to zero disables SEARCH mode

Press **DOWN** to view the next SEARCH screen.

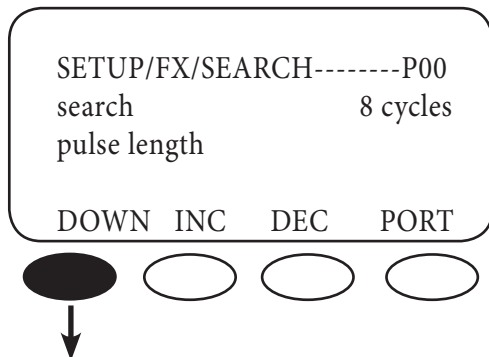

The FX produces pulses to detect AC loads. The *search pulse length* screen allows adjusting the number of pulses (from 2 to 20) or cycles to more reliably detect AC loads. A setting of 8 or higher, adjusted using **INC** and **DEC**, is recommended. Press **DOWN** to open the *search pulse spacing* screen.

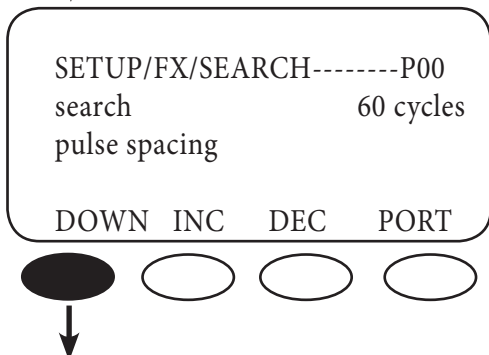

The *search pulse spacing* screen adjusts the amount of time the FX waits before producing additional AC pulses to sense a load. The higher the number of cycles, the lower the FX power consumption, but the longer it takes before the AC load is powered. The cycles range from 4 to 120 cycles (two seconds). Press the **DOWN** to complete the SEARCH menu.

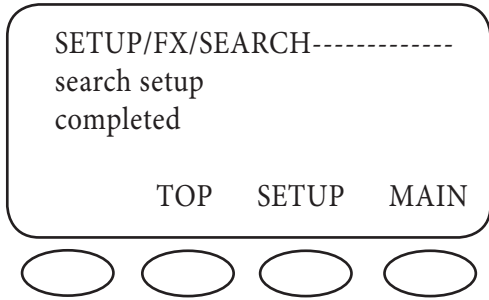

Pressing **TOP** returns you to the SETUP/FX/SEARCH screen.

Pressing **SETUP** returns the user to the *choose category* screen.

Pressing **MAIN** returns to the MAIN Menu.

## INPUT MENU

The INPUT screens allow the user to choose either grid or generator AC input and the maximum amperage from either source that can pass through the FX before a warning occurs.

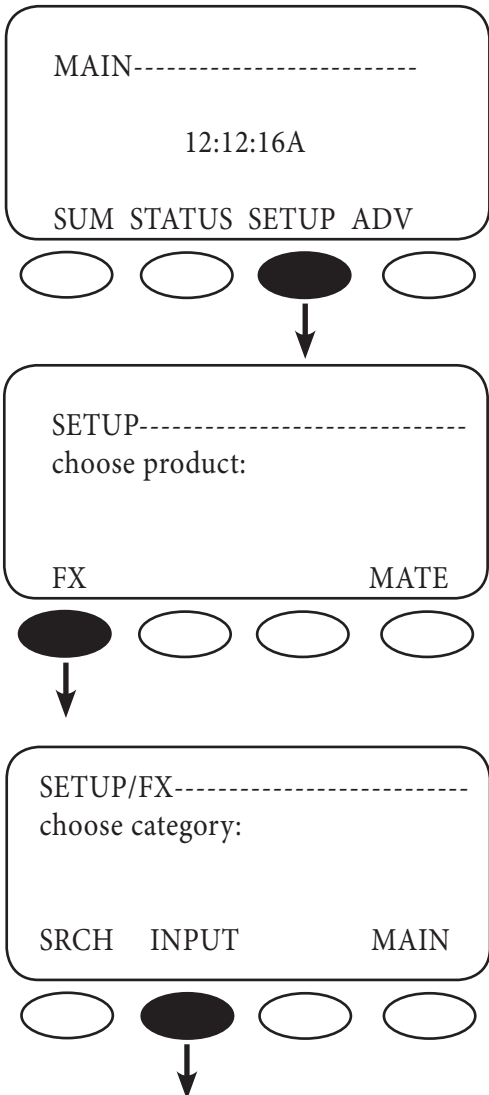

From the MAIN screen, press **SETUP**.

Press **FX**.

Two choices are available in the choose category screen:

- Search (SRCH) adjusts the search mode settings
- INPUT selects the AC INPUT and current limit adjustment

Press **INPUT**.



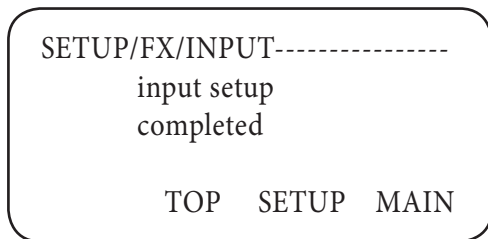
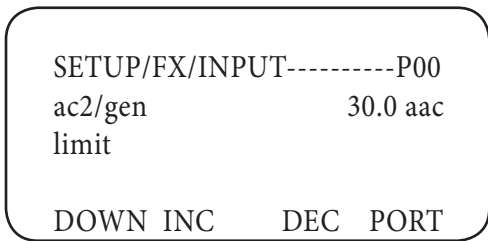
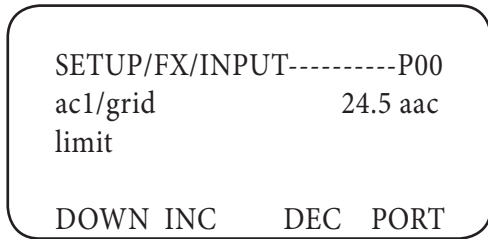
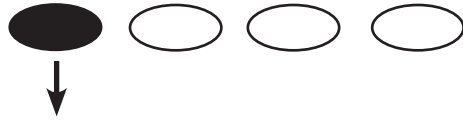
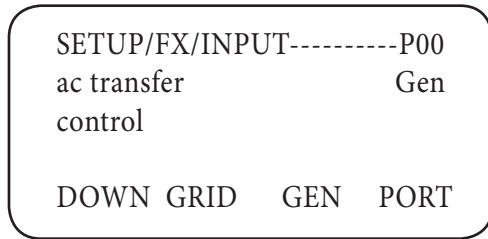

To choose your AC input source in the *ac transfer control* screen, press **GRID** or **GEN**. Press **DOWN** to view the next screen.

By using **INC** and **DEC**, the *ac1/grid* menu sets the maximum current the FX will allow to be drawn from the grid by either AC loads and/or the batteries (during recharging). When this limit is exceeded, an AC input limit warning appears and the FX will reduce the amount of charging so that the total current draw does not exceed the maximum setting (between 2.5AAC and 30.0AAC). Press **DOWN** to view the next INPUT screen.

The *ac2/gen limit* screen sets the maximum current the FX will allow to be drawn from a generator by either AC loads or the batteries (during recharging). When this limit is exceeded, the FX will reduce the amount of charging current so the total current draw does not exceed the maximum setting (between 1.0AAC and 30.0 AAC) to avoid damage to the generator. Press the **DOWN** to view the final INPUT screen.

Pressing **TOP** returns you to the SETUP/FX/SEARCH screen.

Pressing **SETUP** returns the user to the *choose category* screen.

Pressing **MAIN** returns to the MAIN Menu.

## ADVANCED SCREENS

All the FX operation settings can be adjusted in the MATE's ADVANCED screens, including some previously discussed in the INPUT and SETUP menus. Changing the settings under any menu will affect the values in all menus. The ADVANCED screens are accessed via the password 141.

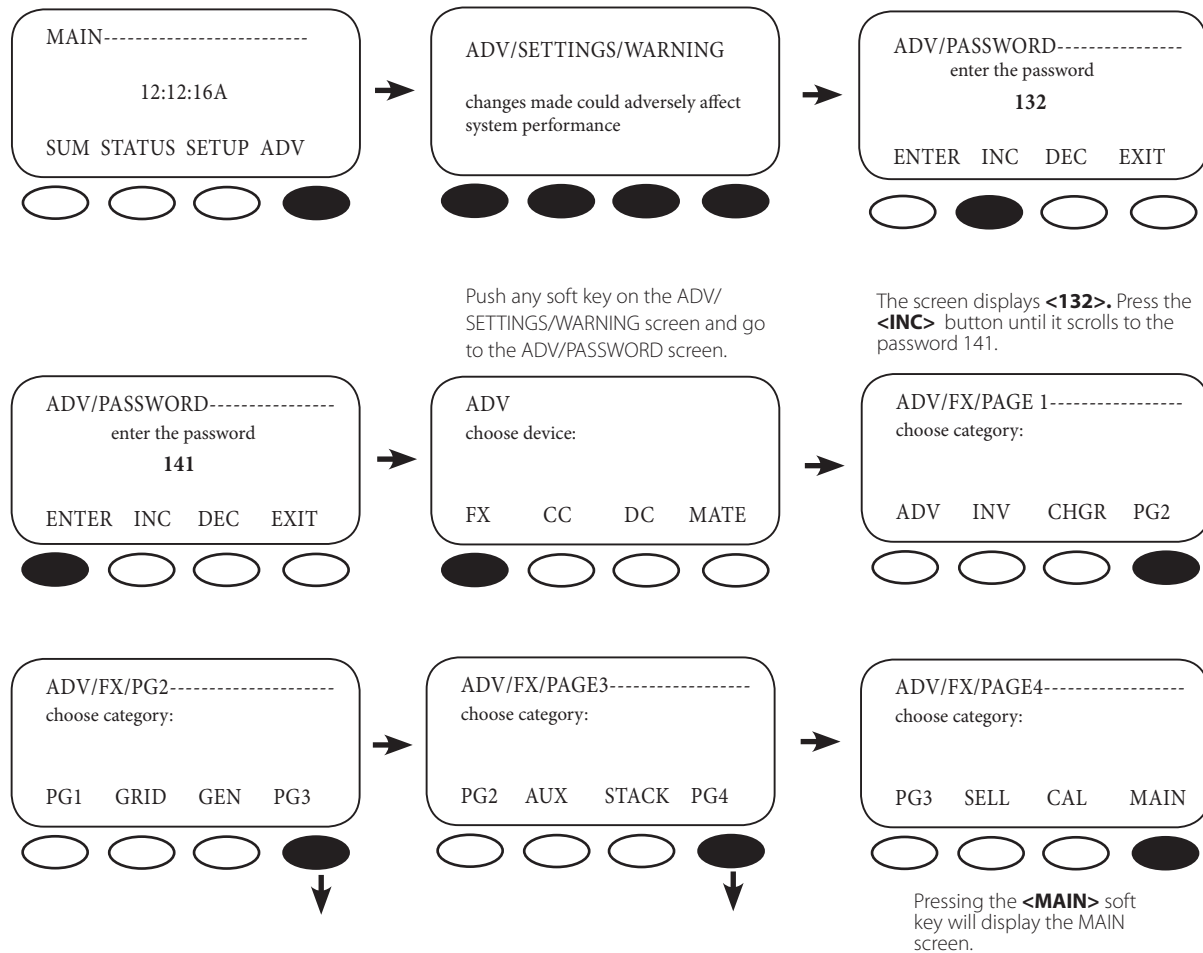

The FX settings and their adjustments include:

- INV—INVERTER
- CHGR—CHARGER
- GRID—AC input if the FX input is set to GRID
- GEN—AC input if the FX input is set to GEN
- AUX—AUX OUTPUT
- STACK—Master and Slave designations when multiple FXs are in use
- SELL—Grid-Interactive FX operations
- CAL—Adjusts voltage calibration measurements for improved operation

## INVERTER MENU

The INVERTER screens allow adjusting the inverter's operations to match the AC load and battery recharging requirements, including the search functions, low-battery cut-out, the FX's output voltage, and resetting the FX to its factory default values.

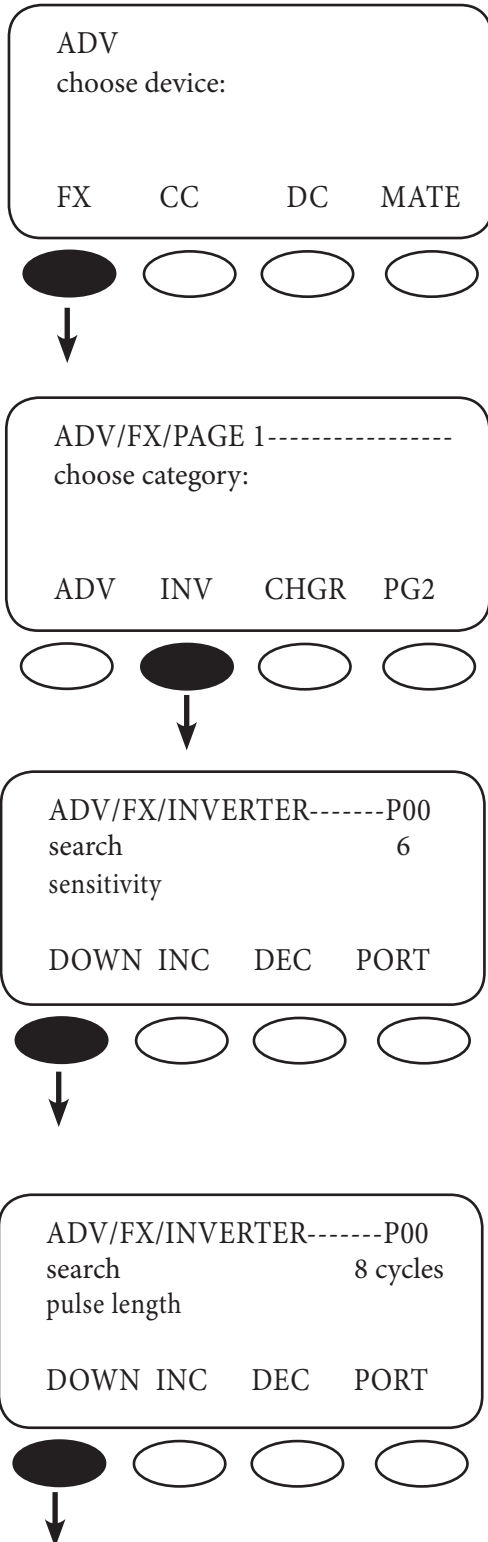

After entering the ADVANCED screens, press **FX** on the *choose device* screen.

Press **INV**.

Use the *search sensitivity* screen to determine the size of an AC load needed for the FX to turn ON and leave SEARCH mode.

- Pressing **INC** decreases sensitivity (a bigger load is needed to turn the FX on)
- Pressing **DEC** increases the sensitivity which means a smaller load (less wattage) will turn the FX on
- Decreasing to zero disables SEARCH mode  
Press **DOWN** to view the *search pulse length* screen.

The FX produces pulses to detect AC loads. The *search pulse length* screen allows adjusting the number of pulses (from 2 to 20) or cycles to more reliably detect AC loads. A setting of 8 or higher, adjusted using **INC** and **DEC**, is recommended. Press **DOWN** to open the *search pulse spacing* screen.

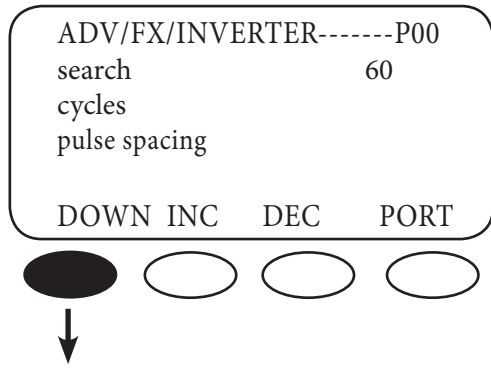

The *search pulse spacing* screen adjusts the amount of time the FX waits before producing additional AC pulses to sense a load. The higher the number of cycles, the lower the FX power consumption, but the longer it takes before AC loads are powered. The cycles range from 4 to 120 cycles (two seconds). Press **DOWN** to view the *low battery cut-out* screen.

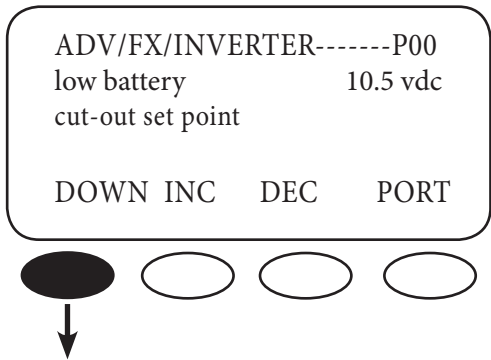

*low battery cut-out* establishes when the FX turns off to avoid draining the battery. If an AC source is available and AC INPUT is set to DROP, the FX will transfer the AC loads on the FX to the AC source. A built-in five-minute delay reduces nuisance FX shutdowns. This setting's range is between 9.0VDC and 12.0VDC. Press **DOWN** to view the next INVERTER screen.

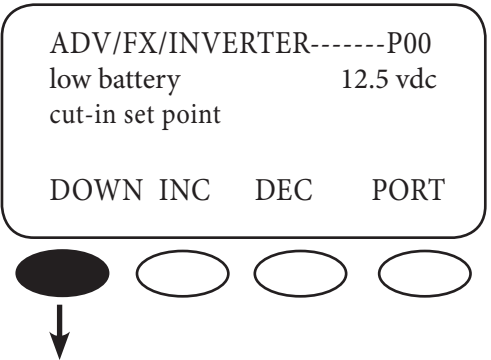

The *low battery cut-in set point* determines when the FX will turn on after shutting off due to a low battery voltage. A 10-minute fixed delay reduces on and off system cycling. This setting's range is between 10.0VDC and 14.0VDC. Press **DOWN** to view the *adjust output voltage* screen.

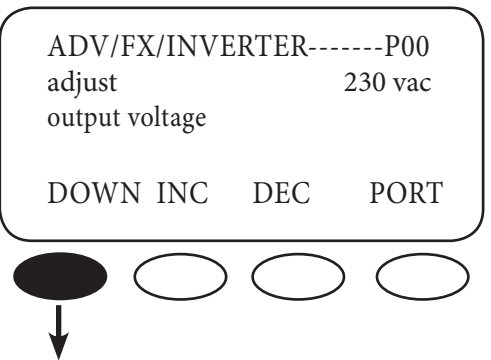

A user can adjust the inverter function's output voltage using this screen. Adjustments might be necessary if some loads are far away from the FX or if some are sensitive to higher voltages. This setting's range is between 220VAC and 250VAC. Press **DOWN** to view the next INVERTER screen.

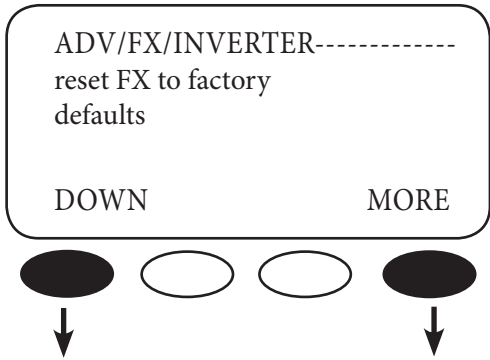

Use this screen to reset the FX to its factory default set points. This will cause all previous programming changes to be lost. Press **MORE** to choose the HUB port whose FX is to be reset and then press **PORT** or, if no HUB is in use, press **NEXT**. Press **DOWN** to skip resetting to factory defaults.

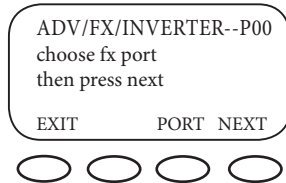

To reset to factory defaults, press **PORT** if a HUB is used until the chosen port number appears or press **NEXT** if this is a single FX system.

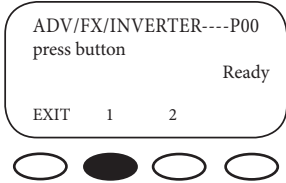

To complete the reset, press the **<1>** soft key and then the **<2>** soft key.

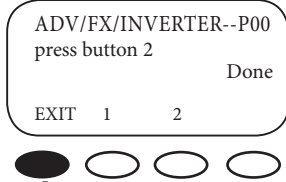
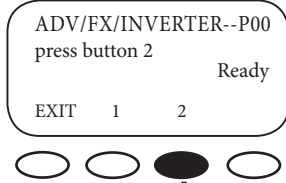

Press **EXIT** to exit the INVERTER screens.

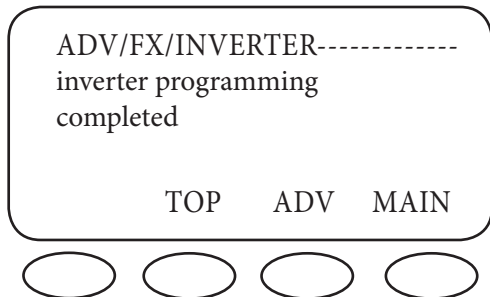

Pressing **TOP** returns to the beginning of the ADV/FX/INVERTER menu.

**ADV** returns to the ADVANCED screens and **MAIN** displays the MAIN screen.

## CHARGER MENU

Each battery manufacturer has specific recharging directions and guidelines. OutBack's default values work for many batteries, but might not be the ideal settings. The CHARGER Menu allows these settings to be adjusted. Please refer to your manufacturer's recommendations.

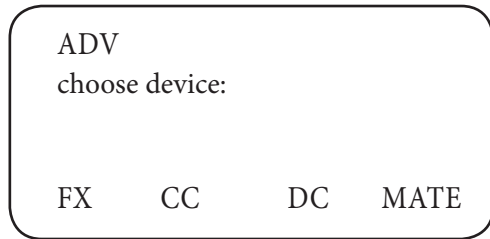

From the ADVANCED menu, press **FX**.

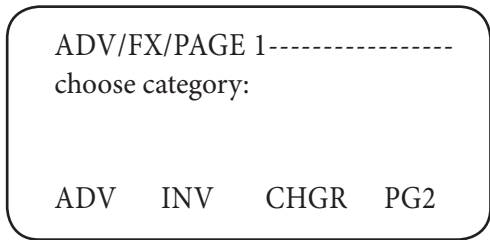

Press **CHGR**.

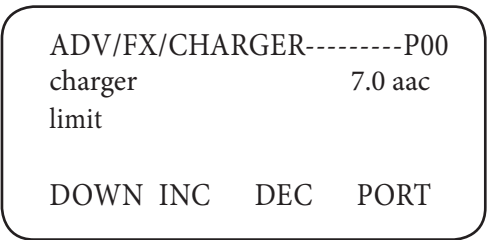

The *charger limit* is the maximum AC current the FX uses to charge the batteries. Depending on the FX model, the setting range is as low as 0.0 AAC to between 6.0AAC and 10.0AAC using **INC** and **DEC**. Press **DOWN** to continue in the CHARGER Menu.

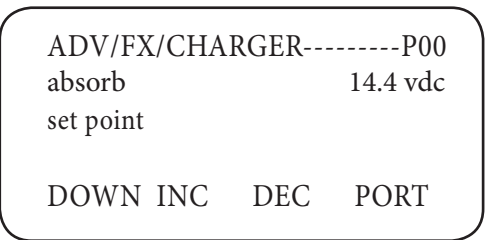

The *absorb set point* is the first stage (BULK) recharging voltage for the batteries. This set point ranges from 13.0VDC to 16.0VDC as determined using **INC** and **DEC**. Press **DOWN** to view the *absorb time limit* screen.



ADV/FX/CHARGER-----P00  
 absorb 01.0 hrs  
 time limit

DOWN INC DEC PORT

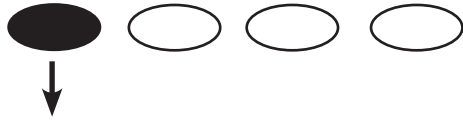

ADV/FX/CHARGER-----P00  
 float 13.6 vdc  
 set point

DOWN INC DEC PORT



ADV/FX/CHARGER-----P00  
 float 01.0 hrs  
 time period

DOWN INC DEC PORT



ADV/FX/CHARGER-----P00  
 refloat 12.2vdc  
 set point

DOWN INC DEC PORT



The *absorb time limit* must be long enough for the batteries to regain 95-100% of their charge. This time limit can be set between 0 hours and 24 hours using **INC** and **DEC**. The FX automatically reduces this limit when it's connected to a partially charged battery. Press **DOWN** to continue in the CHARGER Menu.

The *float set point* is the batteries' finishing charge which completes the recharging process. This setting ranges from 12.0VDC to 15.0VDC. Press **DOWN** to continue.

The *float time period* is the amount of time—from 0 to 24 hours—the recharging process maintains the *float set point*. Larger batteries will probably require more time than smaller batteries. The recharging stops when the *float time period* is satisfied. Press **DOWN** to view the next screen.

When the battery voltage falls below the *refloat set point*, a float cycle recharging starts. This can act as a maintenance recharging or a recharging when intermittent DC loads are running and an AC source is available for recharging. This setting ranges between 12.0VDC and 13.0VDC. Press **DOWN** to view the next CHARGER screen.

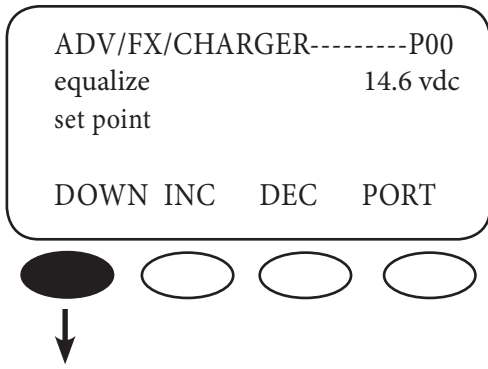

An occasional equalize charge helps de-stratify the batteries for a longer working life. Pressing the **AC IN** hot key leads to screens that begin the equalize charge. The *equalize set point* determines the recharging voltage, which can range between 14.0VDC and 17.0VDC (consult your battery manufacturer for a specific voltage) using **INC** and **DEC**. An equalize recharging should be supervised until completed. Press **DOWN** to continue.

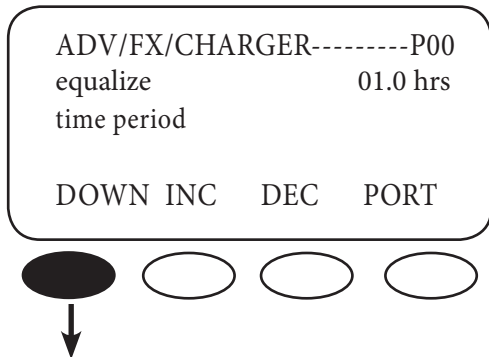

The *equalize time period* limits the equalizing recharge time. The timer begins advancing once the battery voltage exceeds the *absorb voltage set point*. When the *equalize time period* is met, the recharging stops. It is adjustable between 0 hours and 24 hours using **INC** and **DEC**. Press **DOWN** to view the last CHARGER screen.

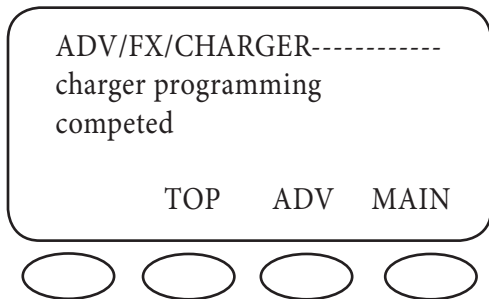

Pressing **TOP** returns to the first ADV/FX/CHARGER screen. Pressing **ADV** returns to the ADVANCED screen. Pressing **MAIN** brings up the MAIN screen.



## GENERATOR MENU

OutBack FX and VFX Inverter/Chargers are programmed to use an AC generator as their default source of AC input. The CHARGER GEN screens allow a user to adjust the input voltage window and time delay of the AC input.

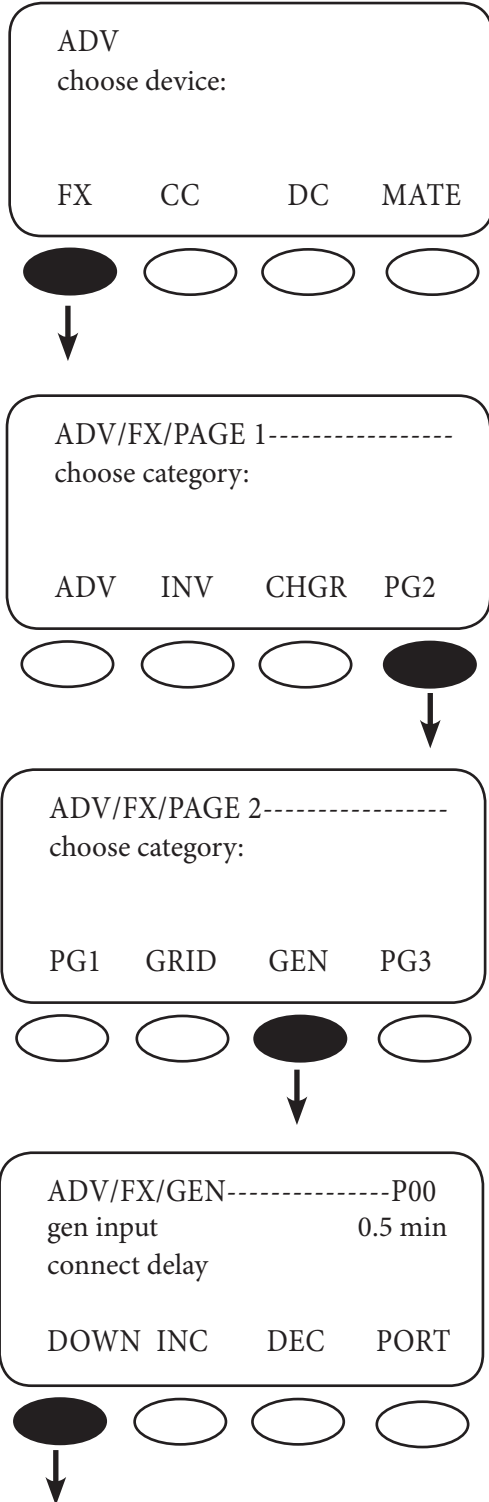

From the ADVANCED screen, press **FX**.

Press **PG2**.

Press **GEN** to adjust the AC input set points and operation.

The *gen input connect delay* is the time period between the FX's recognizing an acceptable generator source of AC and connecting that source to AC loads. This delay allows the generator to warm up and has a range between 0.2 minutes and 15 minutes which are adjusted with **INC** and **DEC**. Press **DOWN** to view the next GEN screen.

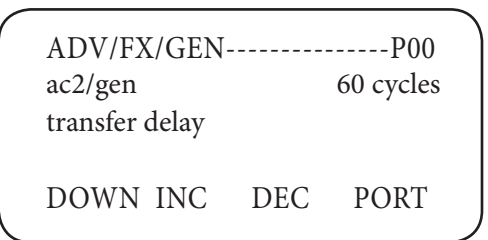
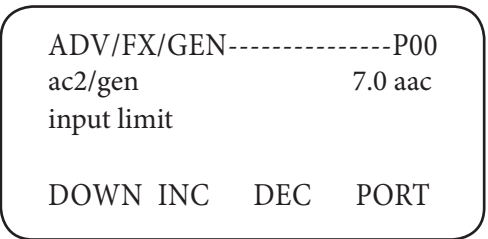
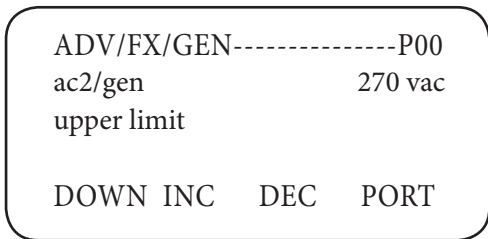
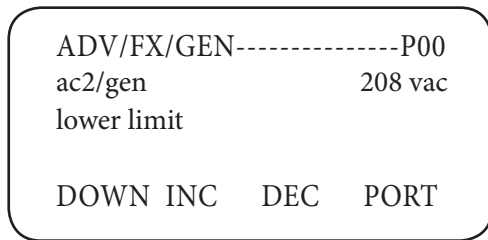

The *ac2/gen lower limit* is the lowest allowable voltage for the FX to connect to the generator. If the voltage falls below this limit, the FX will disconnect from the generator. This voltage value is adjusted using **INC** and **DEC** for values between 80VAC and 220VAC. Press **DOWN** to continue viewing the generator screens

The *ac2/gen upper limit* is the highest allowable voltage for the FX to remain connected to the generator. If the voltage is higher than this limit, the FX will disconnect from the generator. This voltage value is adjusted using **INC** and **DEC** for values between 250VAC and 300VAC. Press **DOWN** to view the *ac2/gen input limit* screen.

The *ac2/gen input limit* is the maximum current the FX can draw from a generator. When this limit is reached, the FX reduces its battery charging function to prevent overloading the generator. If the generator exceeds this limit, the FX will start blinking the red ERROR LED as a warning. This setting's range is 1.0AAC to 30.0AAC, adjustable using **INC** and **DEC**. Press **DOWN** to continue.

The *ac2/gen transfer delay* is the amount of time the FX remains connected to the generator after the AC input voltage drops below the *ac2/gen lower limit* setting. This setting is adjusted between 0 and 240 cycles using **INC** and **DEC**. Press the **DOWN** soft key to view the next GEN screen.

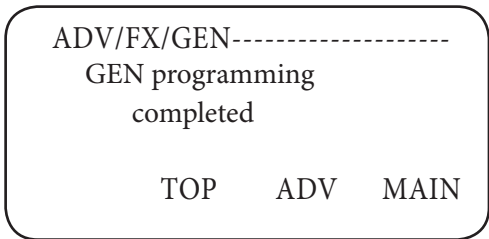
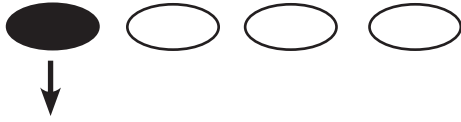
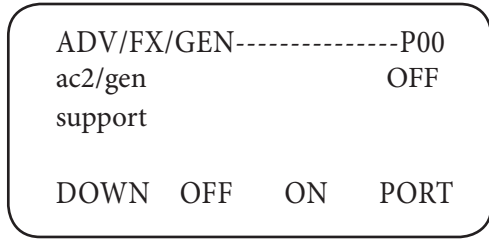

This feature is not operational at this time. Press **DOWN** to view the final GEN screen.

Pressing **TOP** returns to the beginning of the ADV/FX/INVERTER menu. **ADV** returns to the ADVANCED screens and **MAIN** displays the MAIN screen.

## FX SERIES INVERTER/CHARGER PROGRAMMING

**NOTE:** Please see the *International FX and VFX Series Inverter/Charger Installation Manual* to install, wire, and connect each FX. This programming manual assumes all FXs have been installed and are ready to program according to the way they were wired. If a different programming is desired, the FXs might require a different wiring configuration (see sample wiring diagrams in the *FX and VFX Series Inverter/Charger Installation Manual*). To familiarize yourself with the programming concepts, please read through the entire manual before programming your system.

Up to ten off-grid FXs or three FXs in a three-phase system can be combined and wired or “stacked” for systems requiring more power. A user’s final loads and power needs determine which stacking configuration will work best.

- Stacking FXs does not refer to physically placing one FX on top of another, but to how they are wired within the system and then programmed for operation. Stacking allows all the FXs to work together as a single system.
- Stacking assigns the FXs to power individual legs of the system and to operate at certain times; this order is assigned using the MATE.
- **NOTE:** An OutBack MATE is required to recognize and program the FXs. When multiple FXs are used, each needs to be assigned a status—Master or Slave.
- The Master FX is the primary and most heavily used unit. The loads and demands of the system determine when and which Slaves are used. A Slave FX assists when the load demands are more than the Master FX can handle alone.
- This is an orderly process as long as the user assigns each FX correctly. It is mainly a matter of paying attention to the Port number for each FX when programming with the MATE.

### Stacking Concerns

FXs should be wired and stacked appropriately to their individual power system. Problems can occur when:

- An FX is incorrectly wired.
- An FX plugged into a HUB Port is mistakenly programmed (assigned the wrong status) or misidentified.
- ***An easy rule to remember is any FX wired to a specific phase or leg must be programmed to that phase.***

### Stacking Options

The International Series FX and VFX Series Inverter/Chargers can be stacked in the following configurations (see page 23).

1. OutBack Parallel
2. 3-Phase

Each stacking option has benefits and should be chosen according to a user’s needs and individual power system. Consult with your dealer or installer to determine what will work best for you.

## COMPONENTS AND CONNECTIONS:

1. With all AC and DC breakers OFF, connect all FXs to the HUB with individual lengths of CAT5 cable.

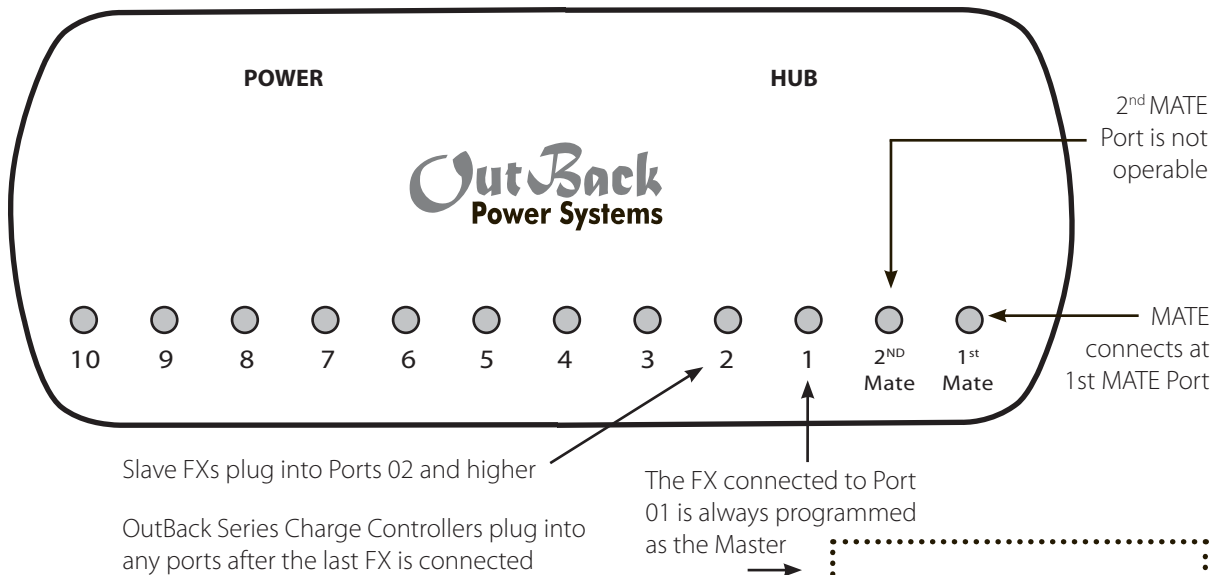
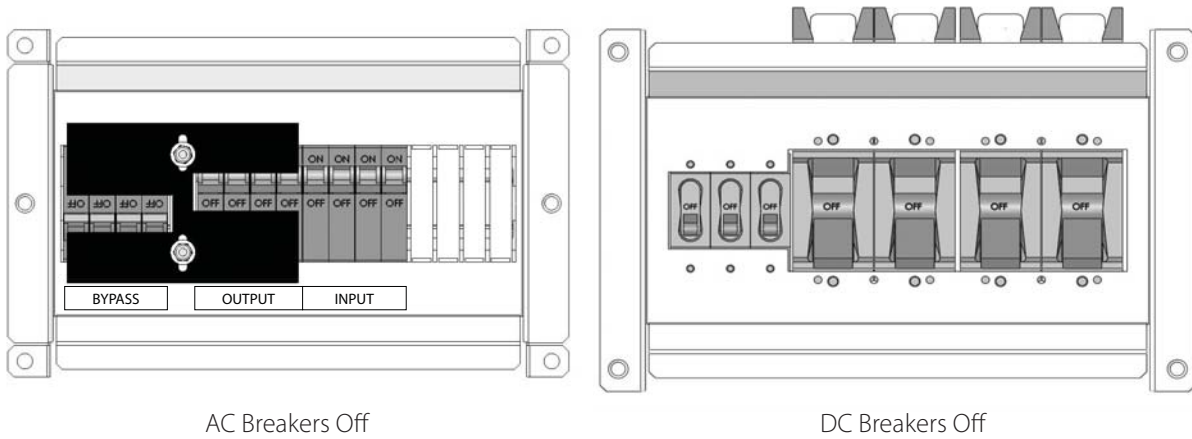

- Connect the OutBack MATE after all other components, including any OutBack Charge Controllers, have been connected and powered up.
- Components installed after powering up the system will require repolling the MATE (please see page 22).
- With the MATE, a user assigns a status and stacking value to the FX on each Port. These status and value assignments can be changed at anytime as long as the Master FX is plugged into HUB Port 01.

- "1-2ph Master" for one and two-phase systems
- "3ph Master" for a 3-phase system
- The Master FX is always considered to be the leg one phase.

**NOTE:** Pay attention to the Port number on the screen! Be sure the FX whose status and stacking value you're changing is the one you mean to change.

2. With the FXs connected to the HUB, turn only the DC breakers ON and power up the components. All AC breakers should be OFF.

**NOTE:** For 3-phase stacking, the jumper in the HUB must be set to the 3- ph position. See the *HUB User Manual* for further information.

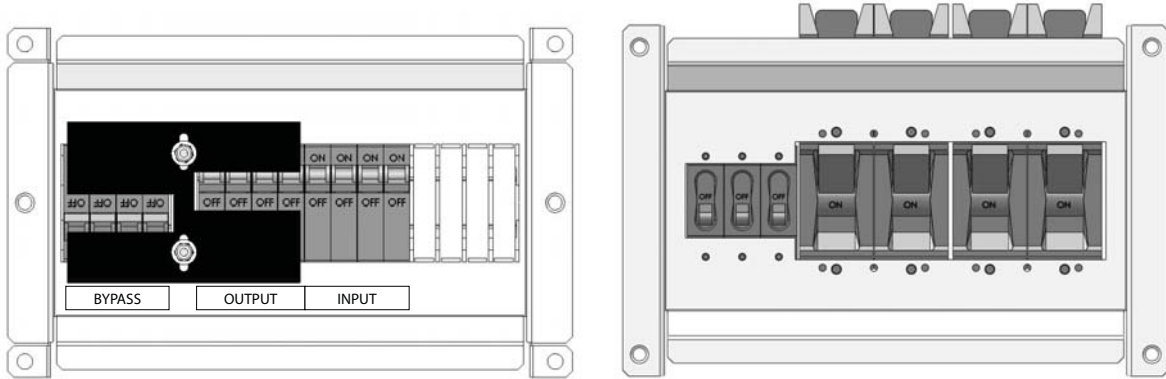

AC Breakers Off

DC Breakers On

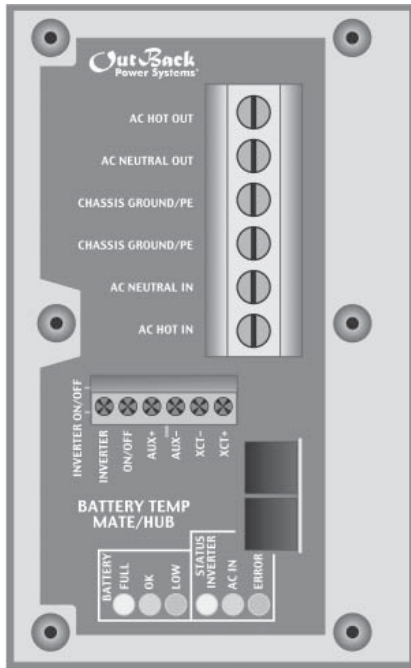

LED Color	LED Action	LED Indicates
Green	Solid GREEN →	Inverter ON
	Flashing GREEN →	Search Mode Standby
	Off →	Inverter OFF
Yellow	Solid YELLOW →	AC Source is Connected
	Flashing YELLOW →	AC Input Live-Waiting to Connect to the FX
	Off →	No AC Input Present
Red	Solid RED →	Error-Error Message, displays on the MATE
	Flashing RED →	Warning: Non-critical FX fault, the MATE can access this information

**NOTE:** Powering up the FXs can cause the red ERROR STATUS light to blink. After 5-10 seconds, the green INVERTER light should be bright and the ERROR and AC IN lights dark. The FX is now producing AC output voltage.

3. After powering up the components, connect the MATE to the HUB.



- a) Plug the MATE into the 1st MATE Port on the HUB.
- b) The MATE will power up and should recognize any component connected to the HUB.
- c) The MATE can then program the FXs.
- d) The fifth MATE screen (*Port Assignment*) should display all the FXs and any OutBack Charge Controllers in the system.

**MATE Screens**

PATH	→	→	→	→
G'day Mate	(C) 2007 OutBack Power Systems	Version Code a.aa  Serial #xxxxxxx Screen EE b.bb	Searching for Devices  HUB Found	Port Assignment 1> FX 2> FX 3> CC 4> CC 5> 6> 7> 8> 9> 10> 2M>

4. To verify the MATE recognizes each HUB connected FX and OutBack Charge Controller, disconnect and then either (a) reconnect the MATE to view its boot-up and repoll sequence or (b) follow this path to manually repoll:

PATH	→	→	→	→
MAIN----- 12.15:30p	SETUP----- choose device:	SETUP/MATE/PAGE1 mate code rev: 402 choose category:	SETUP/MATE/PAGE2 choose category:	SETUP/MATE/COMM choose category:
SUM STATUS SETUP ADV	FX MATE	CLOCK CNT GLOW PG2	PG1 SUMRY COMM PG3	BACK REPOLL PC DEBUG



The FXs are now ready to be programmed according to the stacking options described in the next section.

## STACKING OPTIONS

OutBack International Series FXs can be stacked in one of two configurations:

1. OutBack Parallel
2. 3-Phase

**NOTE:** Although stacking 10 FXs is possible, OutBack's AC hardware only accommodates configurations of two, four, or eight FXs. A system with eight FXs would require two AC Input/Output Bypass (IOB) Breaker Kits or installing an external manual bypass; ten FXs would require three IOB kits or an external manual bypass.

### 1. Outback Parallel

- 2-10 FXs are wired to the same 230 VAC output leg or phase.
- The Slave FXs can be programmed to remain at different power levels (*Silent* or *On* depending on the need) to save energy; the Slaves will come on when the power demand requires them.
- This power-saving system is fully automatic and works with or without a MATE connected to the system, although a MATE is required to program the components. Without a MATE, the user cannot reprogram.
- The AC input (generator or grid) must be 230VAC.





## 2. 3-Phase

- Three—and only three— FXs are connected, one to each of three 230 VAC output legs that produce 400 VAC between any two legs of the system.
- The HUB requires a jumper between the two Slave FXs for this stacking to function (see *HUB Communications Manager User's Manual*).
- The AC input source (generator or grid) must be a 230VAC/400VAC 3-phase source.

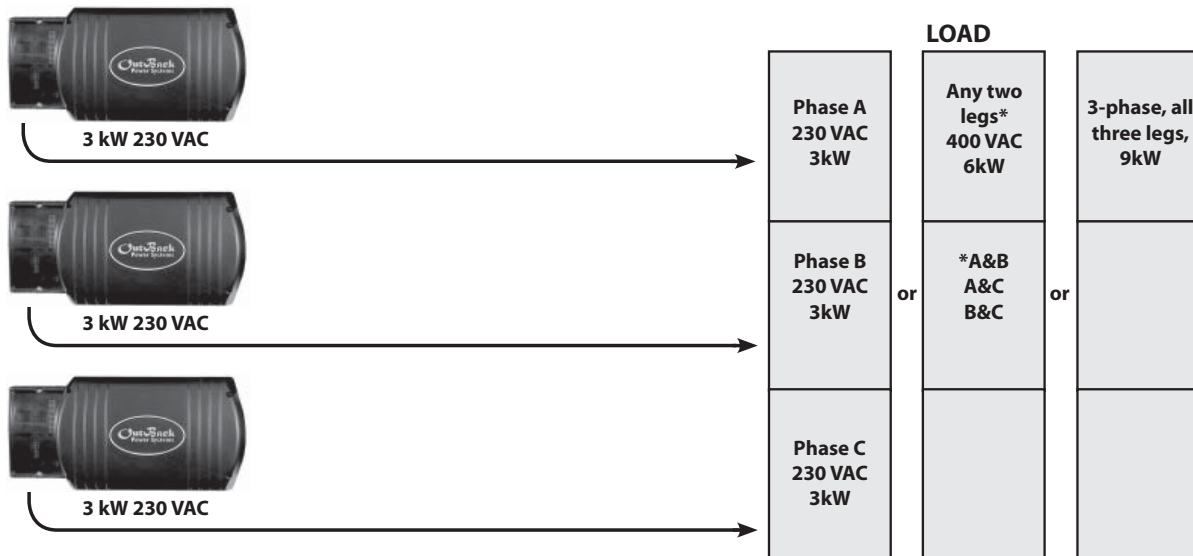

## STACKING AND ASSIGNING FX STATUS

Use the MATE to establish the order or hierarchy of all the system FXs by designating each as one of the following:

- 1-2ph Master (OutBack Parallel, OutBack Series, or Classic Series stacking)
- Classic Slave (Classic Series stacking)
- OB (OutBack) Slave L1 (OutBack Parallel, OutBack Series, or OutBack Series/Parallel stacking)
- OB (OutBack) Slave L2 (OutBack Series or OutBack Series/Parallel stacking)
- 3ph Master (3-Phase stacking)
- 3ph Slave (3-Phase stacking)

**NOTE:** Some stacking options that appear on the MATE should not be used with an International Series FX or VFX and are marked as such in the text.

### 1. 1-2ph Master

- This is the default ranking of every FX. It applies to one-phase and two-phase systems.
- One Master FX is established for every multiple FX system.

## 2. Classic Slave

- Classic Slave is the designation of the second FX in a two-inverter, split-phase system that produces 400VAC without using an FW-X240 Auto Transformer.
- This FX is plugged into Port 02 of the HUB.

This stacking option is not to be used in the International Series FX or VFX.

OB Slave L1 and OB Slave L2 designations are used in OutBack Parallel Stacking or OutBack Series/Parallel stacking

## 3. OB Slave L1

- In an OutBack Parallel single phase system, all the Slave FXs on a single 230 VAC leg are designated OB Slave L1.
- In an OutBack Series split phase system, which will include an FW-X240 or PSX-240 Auto Transformer, any FX that runs in parallel to the Master FX is designated OB Slave L1. These FXs must be plugged into the lowest HUB Ports.
- The OB Slave L1 Stacking is typically used for an entirely off-grid application such as a cabin that does not require 400 volts.

## 4. 3ph Master

- In 3-Phase stacking, the Master FX is designated as 3ph Master.
- 3ph Master and 3ph Slave designation are used in OutBack 3-Phase stacking.

## 5. 3ph Slave

- In 3-Phase stacking, each of the Slave FXs, which should be plugged into HUB Ports 02 (phase B) and 03 (phase C) respectively, is designated as 3ph Slave.
- When the HUB jumper is set between Port 02 and Port 03, the HUB identifies a phase for each Slave FX.

### Stacking Phases/Assigning FX Status (in order):

1. 1-2ph Master
2. Classic Slave
3. OB Slave L1
4. OB Slave L-2
5. 3ph Master
6. 3ph Slave

## PROGRAMMING THE FXs

Once the MATE recognizes each FX (and OutBack Charge Controller), push and hold the first two soft keys simultaneously to return to the MAIN menu. To program the FXs, go to the ADV/FX/STACK menu on the MATE navigating with the following steps:

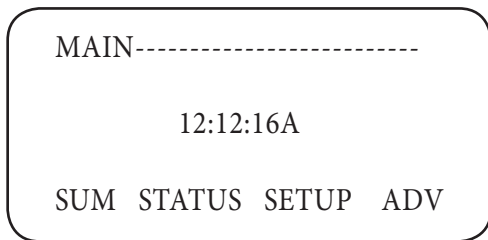

Press the **<ADV>** soft key.

**NOTE:** Pressing and holding the first two soft keys at the same time will always bring up the Main Menu screen.

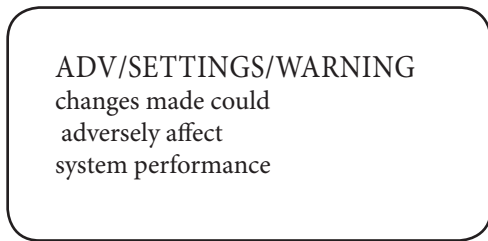

Push any soft key on the ADV/SETTINGS/WARNING screen and go to the ADV/PASSWORD screen.

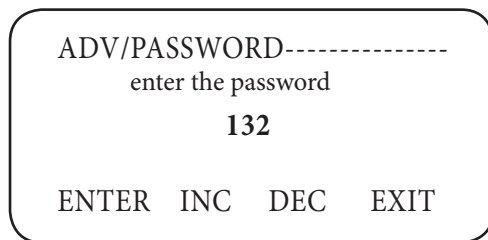

The screen displays 132. Press the **<INC>** button until it scrolls to the password 141.

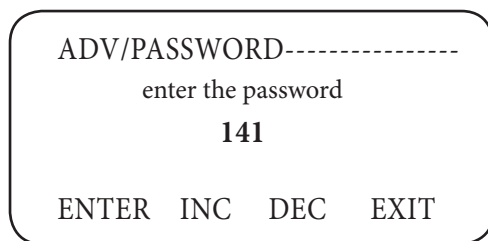

Push the **<ENTER>** soft key.

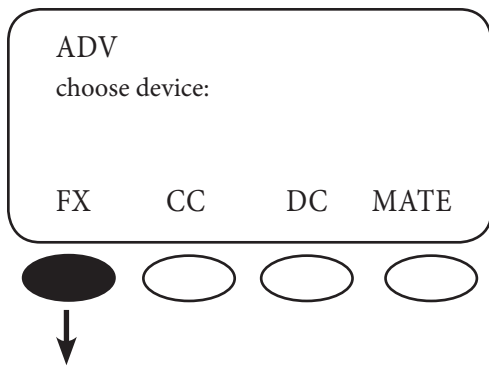

In the ADV menu, press the **<FX>** soft key.

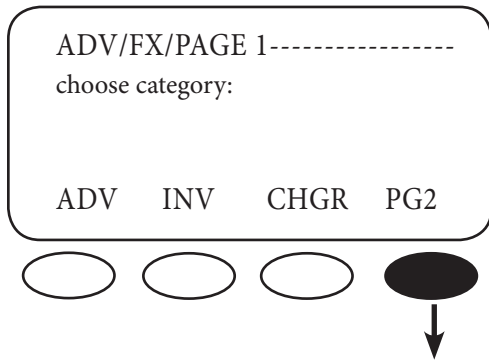

On the ADV/FX/PAGE 1 screen, press the **<PG2>** soft key and go to the ADV/FX/PAGE2 screen.

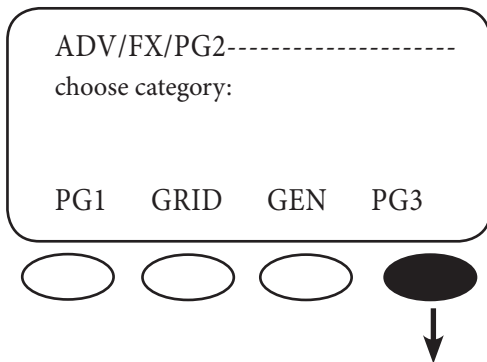

Press the **<PG3>** soft key which leads to the ADV/FX/PAGE3 screen.

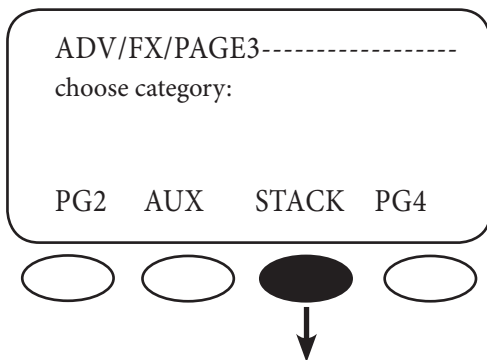

On the ADV/FX/PAGE3 screen, press the **<STACK>** soft key.

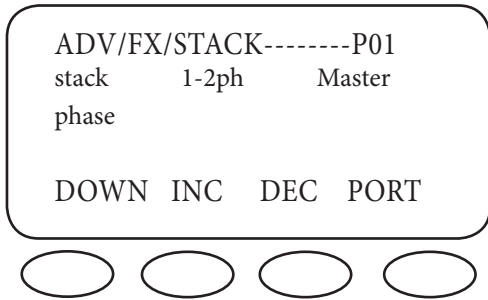

Stacking the FX Series Inverter/Chargers begins on this screen. See specific stacking procedures in the next section.

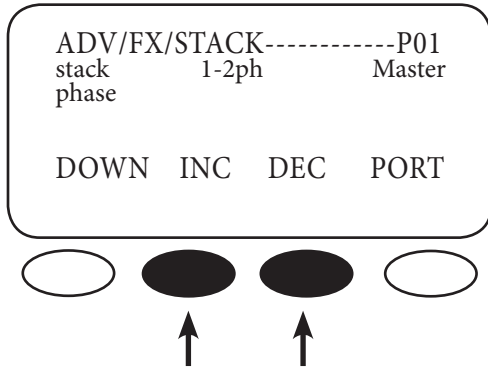

Port 01 always takes the Master FX.

Pressing the **<PORT>** soft key changes the HUB Port whose value you wish to adjust.

Pressing the **<INC>** or **<DEC>** soft keys changes the stacking phase.

## 1-2PH MASTER

With the Port 01 FX as the Master, press the **<PORT>** soft key to change the remaining Ports and designate the remaining FXs as Slaves. The MATE screen for Port 02 will look like this:

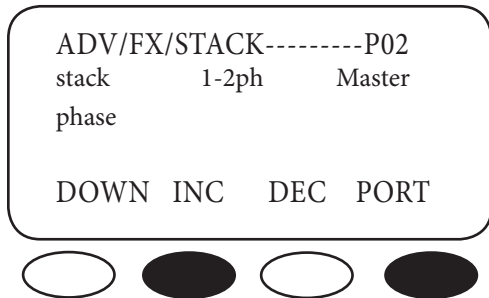

- The MATE is now ready to program the FX plugged into Port 2 of the HUB.
- 1-2ph Master is the factory default value for each FX.

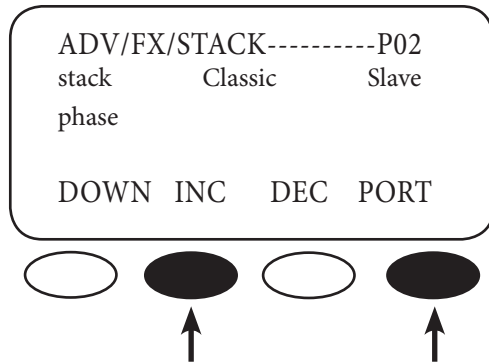

Pressing the **<INC>** soft key will keep the MATE's attention on Port 2, but will change the stack phase to Classic Slave screen. Port 02 will then be assigned as a Classic Slave.

You can change the stacking phase by pressing the **<INC>** or **<DEC>** soft keys and change to a different Port by continuously pushing the **<PORT>** soft key.

**NOTE:** There are no **<OK>** or **<DONE>** commands in the stacking menu. Whichever value—Master or Slave—shows up on the MATE screen will be assigned to the chosen Port (and FX) upon leaving that screen. It's important to watch the Port number in the top right corner of each screen to be sure you've assigned it the desired status.

## OUTBACK (OB) SLAVE

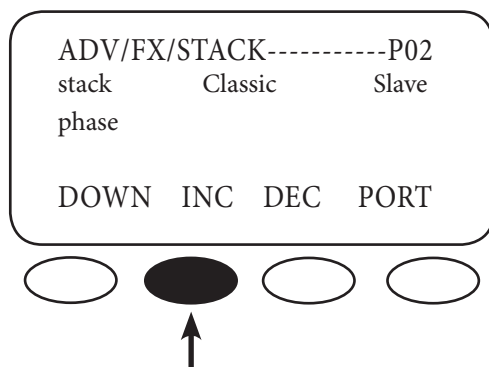

Systems with two to ten FXs call for OutBack Slave Stacking. Press the **<INC>** soft key in the ADV/FX/STACK screen to change the stack phase from Classic Slave to OB Slave L1.

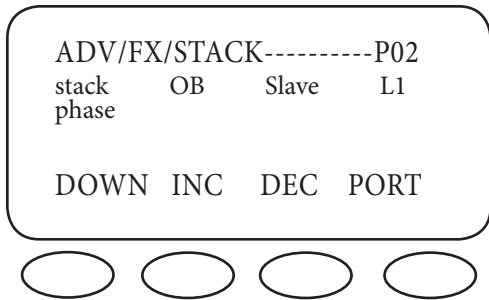

OB Slave 1 stacking phase

### OUTBACK (OB) SLAVE L2

- Set the FXs you want as series slaves (Leg 2) to OB Slave L2.
- This FX is considered the L2 phase.

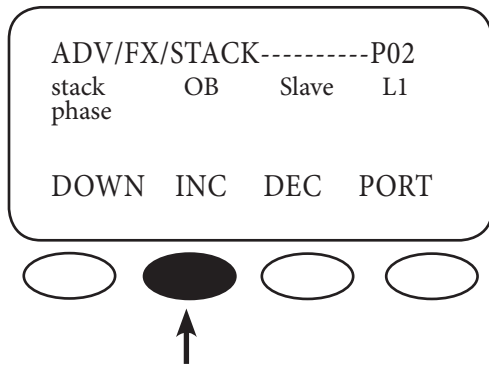

To use OutBack Slave L2 Stacking, press the **<INC>** soft key in the ADV/FX/STACK OB screen to change the stack phase from OB Slave L1 to OB Slave L2.

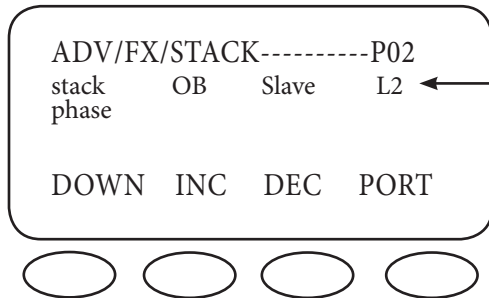

The FX assigned to Port 02 now has *OB Slave L2* status.

### 3-PHASE (3PH) MASTER

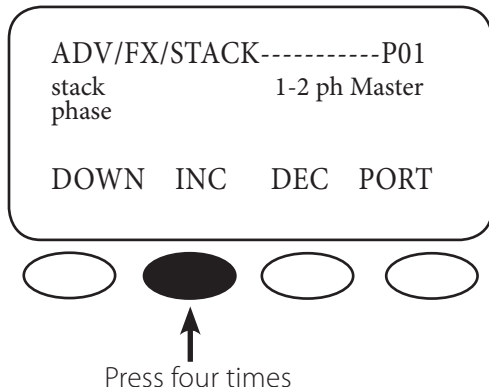

A 3-phase system with only three FXs requires one of two different stacking procedures. Starting from the first stacking menu—ADV/FX/STACK—press the **<INC>** soft key four times.

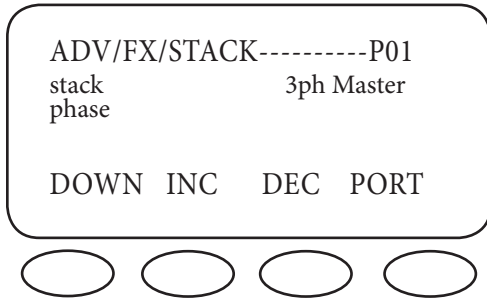

The FX has now been set to 3ph Master status.

### 3-PHASE (3-PH) SLAVE

- Set the two Slave FXs to 3ph Slave and make sure they are in Ports 02 and 03 of the HUB.
- There are no selections to differentiate between phases B and C.
- When you set the jumper in the HUB for 3-phase, the HUB assigns each Slave to its phase. 3ph Slave on HUB Port 2 is considered phase B.
- 3ph Slave on HUB Port 3 is considered phase C.

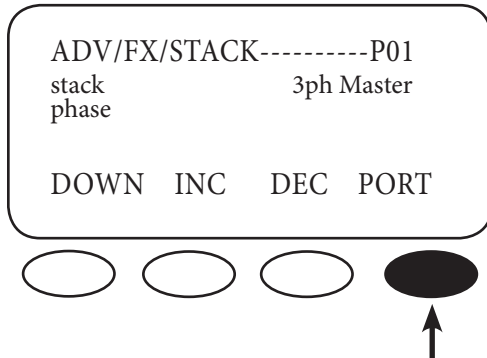

From the 3-ph Master screen, press the **<PORT>** soft key until P02 appears.

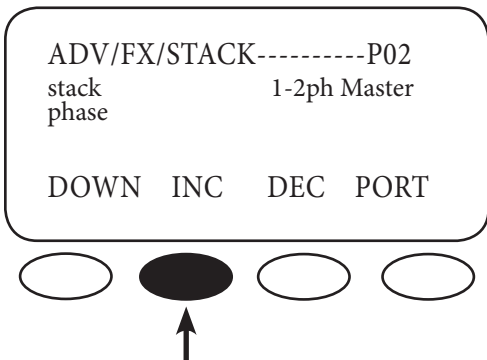

Each new Port screen in the stacking menu will open with 1-2ph Master displayed. To change the stacking designation, press the **<INC>** soft key until 3ph Slave appears.

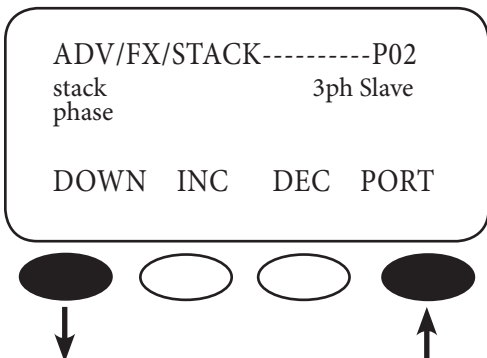

After establishing P02 as a 3ph Slave, move onto P03 and repeat the procedure. Press the **<DOWN>** soft key when finished.



## INTRODUCTION TO POWER SAVE LEVELS

Depending on the model, each FX consumes 20-25 watts of power when it remains on, even if it isn't actively inverting or charging. OutBack Power Systems offers the option to shut down (put into *Silent* mode) some or all of the Slave FXs until the loads require them to come on again.

- When a load exceeds six amps AC, the Master FX shares the load with one or more Slave FXs.
- When the Master detects only a two amp load, a Slave FX goes into Silent mode; Slaves will continue to go into Silent mode as long as the Master detects four amps.

The next two screens in the MATE's Stack menu adjust the power levels of the Master and Slave FXs. From any STACK PHASE screen:

- Press the **<DOWN>** soft key once to bring up the power save level master adjust only screen
- Press the **<DOWN>** soft key again to bring up the power save level slave adjust only screen

**NOTE:** These power save level master adjust only and power save level slave adjust only screens pertain to systems that have OB Slave L1 and/or OB Slave L2 type slaves only.

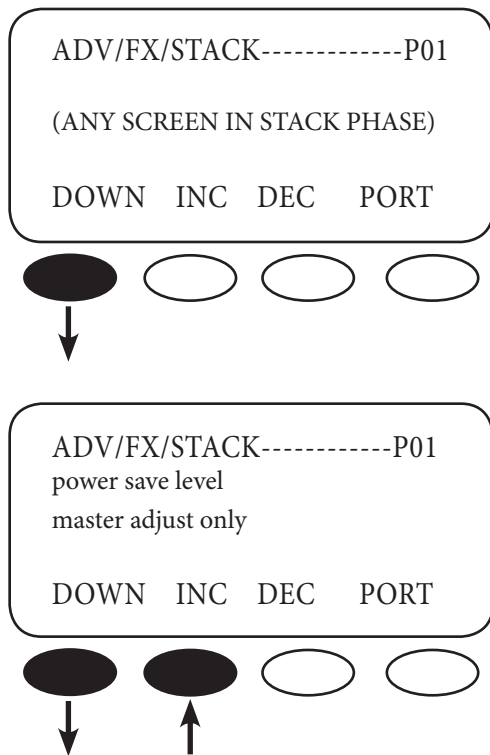

Press the **<DOWN>** soft key once.

Press the **<INC>** soft key to increase the *power save level master adjust only* value. Any Slave with this value or lower, which is assigned in the *power save level slave adjust only* screen (next), will be on with the Master. If the *power save level master adjust only* is three, for instance, any Slave assigned a value of 3 or lower will be on when the Master is on. Since the Master is essentially always ON, these Slaves will always be on as well. Any Slave with a value of 4 and higher will be Silent until the Master activates them for larger loads. For days of the week with small load demands, a user can decrease the *power save level master adjust only* value so fewer FXs are running. The default value is zero (only the Master is on).

Press **<DOWN>** to view the *power save level slave adjust only* screen.

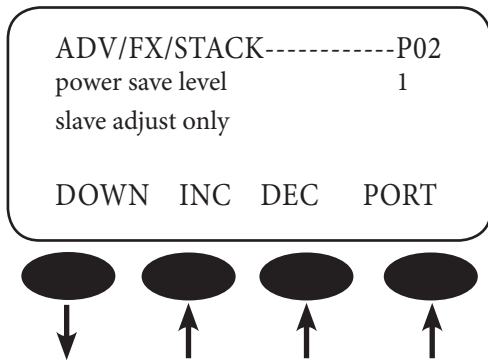

The default value for the *power save level slave adjust only* screen is 1. Press the **<INC>** or **<DEC>** soft keys to adjust this value. Press the **<PORT>** soft key to change the value of each Slave FX.

- The Slave(s) must be connected to Port 2 or higher on the HUB.
- With the Master FX default value of zero in the *power save level master adjust only* screen, all of the Slave FX's will remain OFF until the Master FX needs help and calls for the Slave FXs with "Slave Rank" equal to 1 to come ON.
- Choose a different "Slave Rank" for each Slave FX. This helps assure proper operation and allows them to come ON one at a time saving power in the long run. Otherwise, with a default value of 1 for all Slaves, they will all come on whenever a 12 amp load calls for more power, but then can quickly shut off because multiple FXs provide far more than the required 12 amps. Ranking them 1, 2, 3, 4 etc. means they will come on one at a time as needed to better serve the loads and conserve energy.

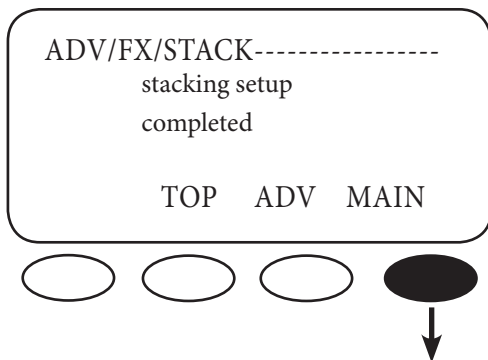

Press the **<DOWN>** soft key to view the final *stacking* screen.

Press the **<MAIN>** soft key to return to the Main Menu.

# POWERING UP

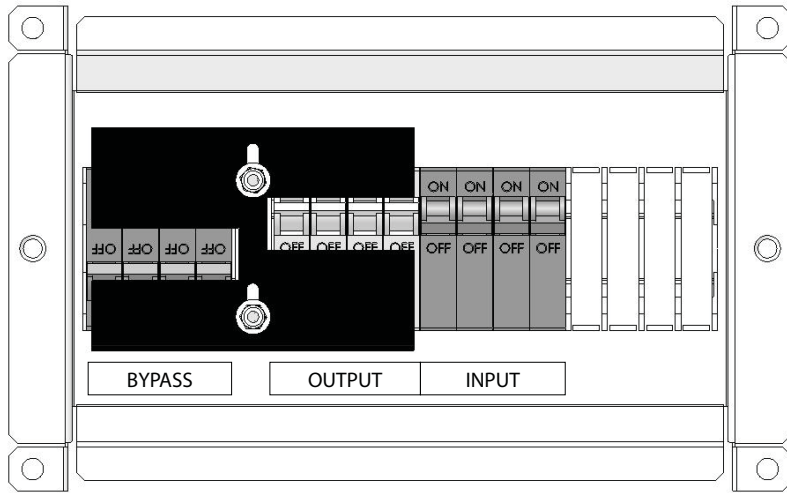

With the programming completed, turn the AC output breakers ON with the AC BYPASS on the AC breaker panel switched to NORMAL.

Verify the AC voltage output through the MATE following path:

PATH	→	→	→	
MAIN----- 12.15:30p	SETUP----- choose device:	STATUS/FX/PAGE1----- choose category:	Float P00 inv 0.0Kw zer 0.0kw chg 0.0kw buy 0.0kw	STATUS/FX/METER—P00 output 230 vac voltage
SUM STATUS SETUP ADV	FX CC DC MAIN	MODES METER BATT PG2	DOWN STATUS PORT	DOWN UP TOP PORT



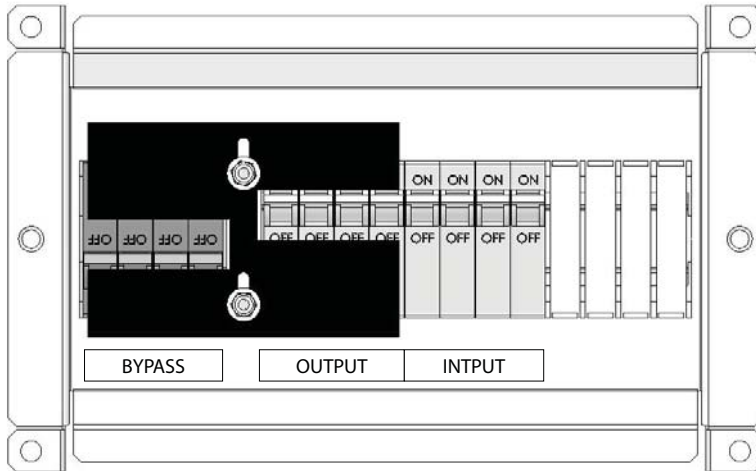

Turn the AC input breakers ON.

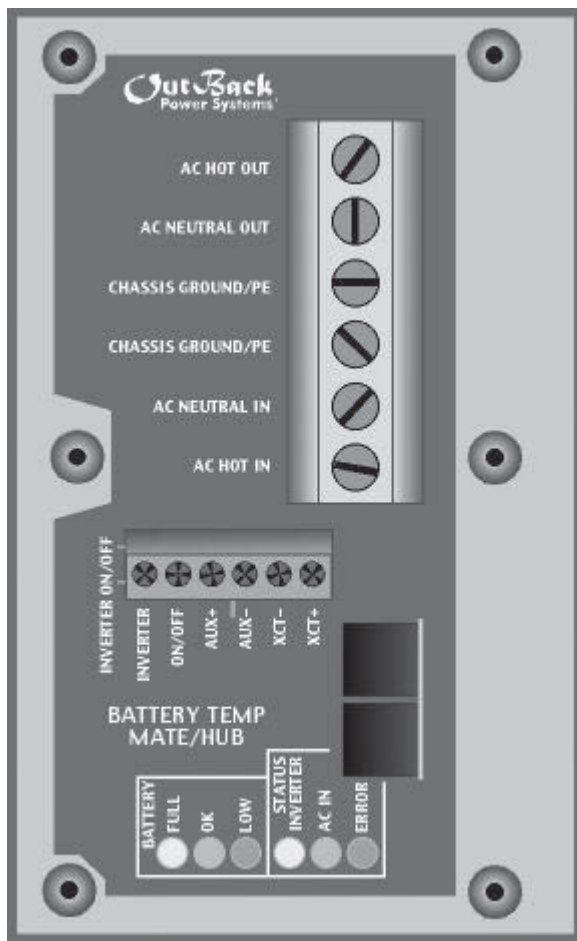

If the FX's AC source is available, the yellow AC IN STATUS light will blink. The FX will connect to the utility grid when the voltage is within 200-260 VAC and the frequency between 45-55 Hz. After about 30 seconds, the AC IN light should stop blinking and stay lit. The FX will now perform a battery charge using the available AC.



## STACKING SYSTEM EXAMPLES

### OutBack Parallel Stacking

- Four FXs in a single system are referred to as a Quad Stack.
- The FX installed at the bottom of the stack is plugged into Port 1 of the HUB.
- The second, third, and fourth FXs are plugged into Ports 2, 3, and 4 respectively.

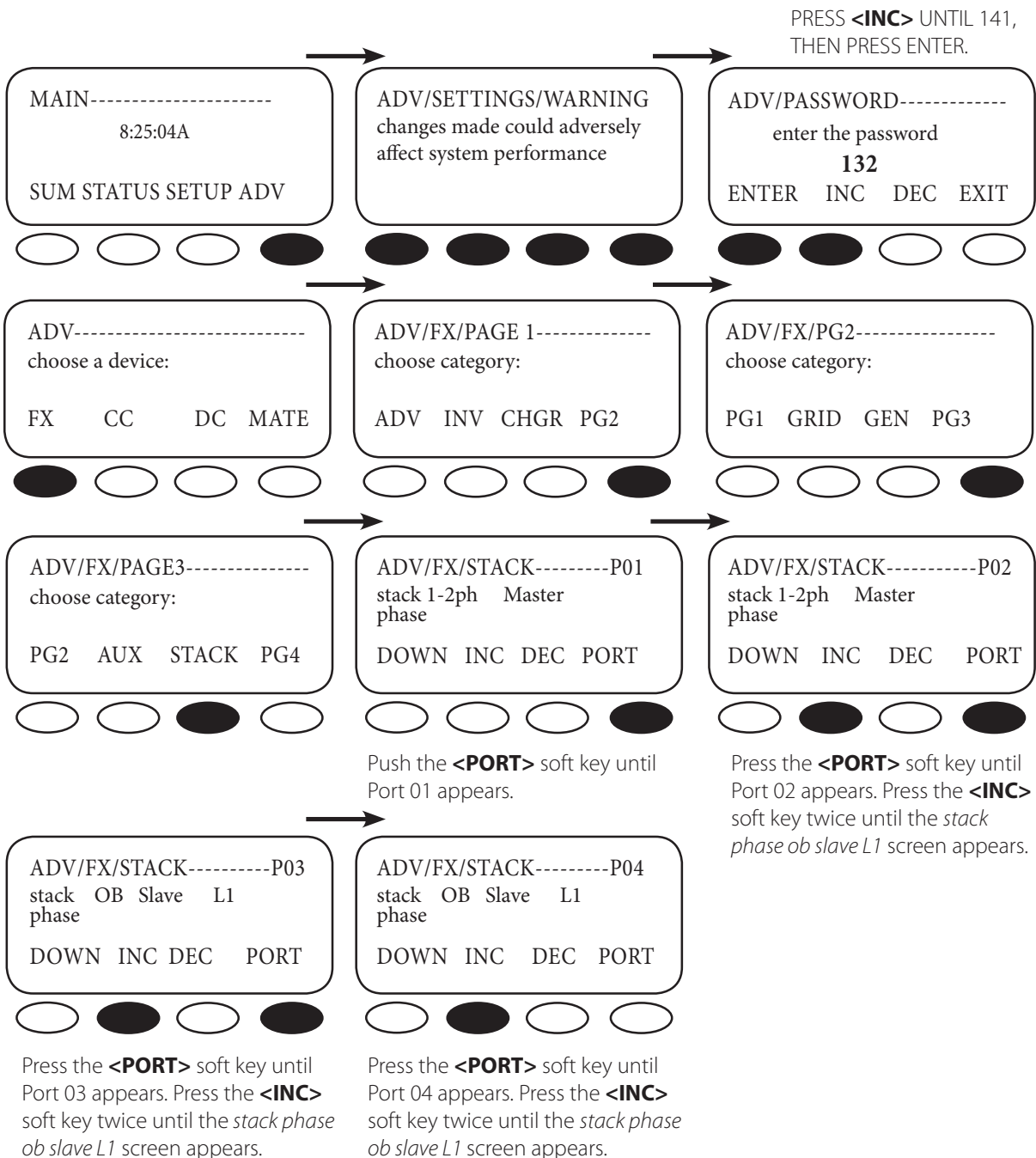

At completion, each Slave FX in Ports 2, 3, and 4 will be in parallel with the Master in Port 01. Additional Slaves can also be programmed as *OB Slave L1* following the instructions above. All the Slave FXs connected to Ports 2, 3, and 4 are now in parallel with the Master in Port 01. Remain in this screen. The next step is to rank the Slaves in relation to the Master.

## RANKING THE SLAVES

Start from the last ADV/FX/STACK screen.

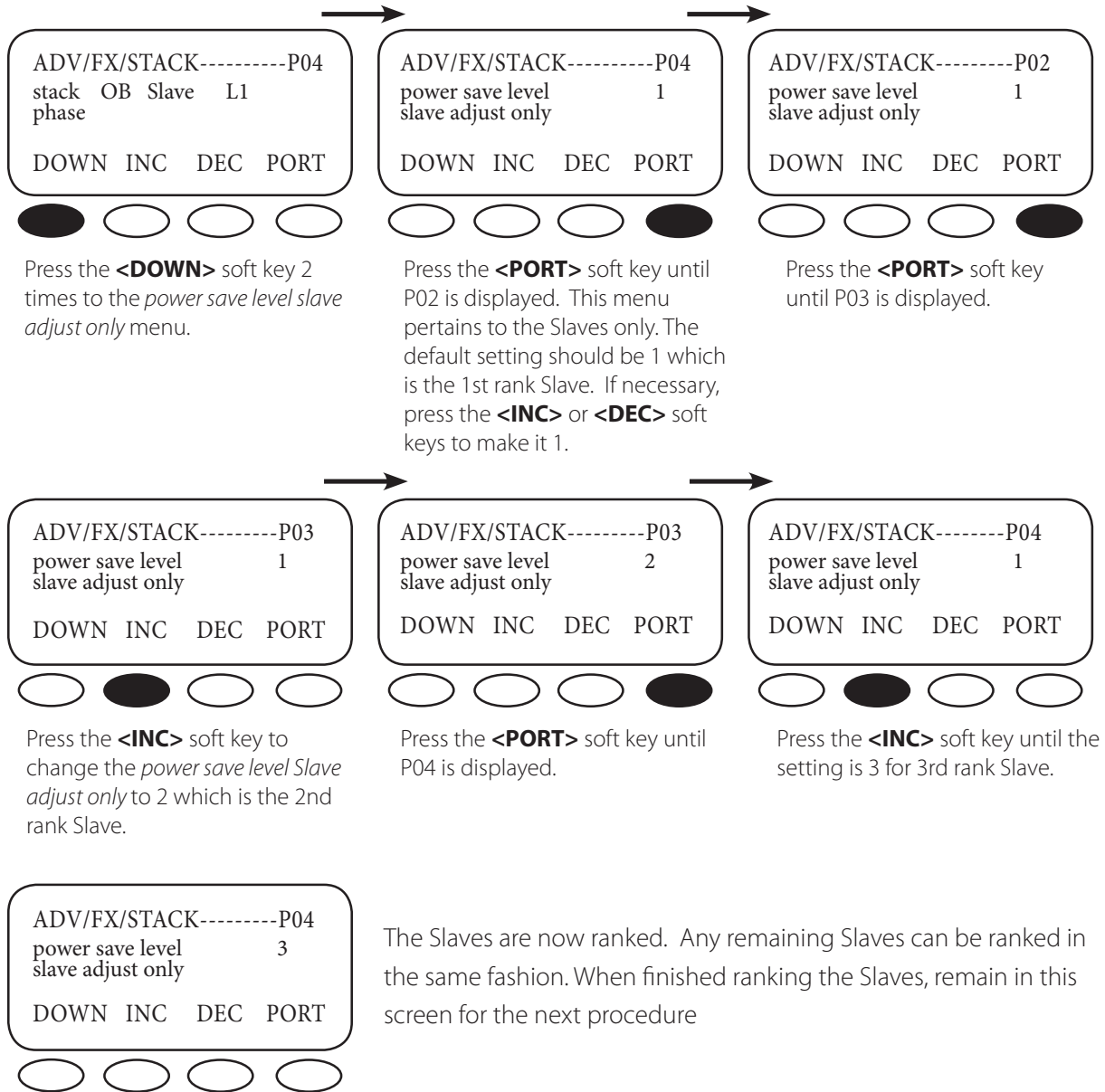

After setting up your OutBack Parallel Stacking and establishing the Master and Slave order, shut off all the AC input and output breakers and check your system via the following MATE screens:

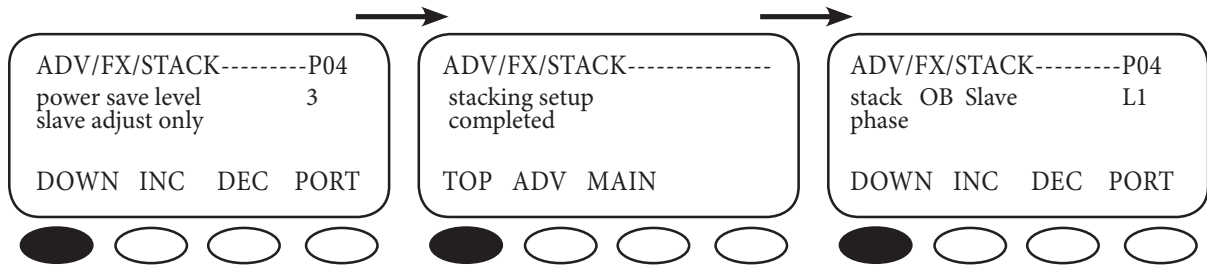

From the ADV/FX/STACK *power save level slave adjust only* screen, press the **<DOWN>** soft key, the **<TOP>** soft key, and then the **<DOWN>** soft key.

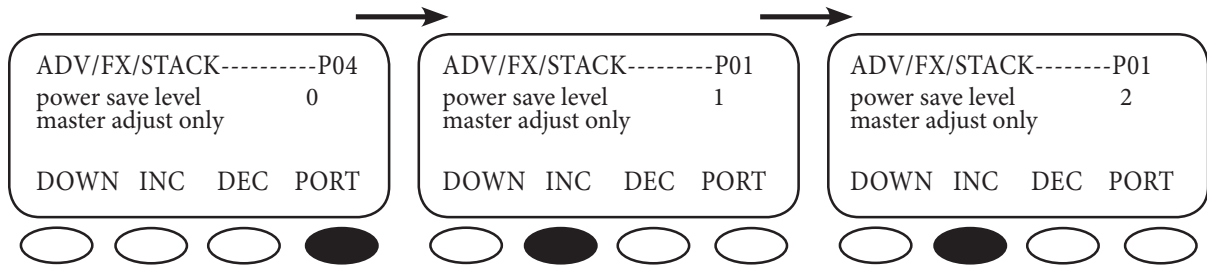

Verify this is the *power save level master adjust only* screen. Press the **<PORT>** soft key until P01 appears on the screen. Turn on all of your FX AC Output breakers. The Master FX's "INVERTER" LED should be solid and all the Slaves "INVERTER" LED's should be blinking.

Press the **<INC>** soft key to adjust the *power save level master adjust only* from 0 to 1 and watch the 1st Slave's "INVERTER" LED go solid. When the "INVERTER" LED is on solid, this means that the inverter is on. When the "INVERTER" LED on the Slave is blinking, this means the FX is asleep.

Press the **<INC>** soft key once to adjust the *power save level master adjust only* to 2 and watch the 2nd Slave's "INVERTER" LED turn on

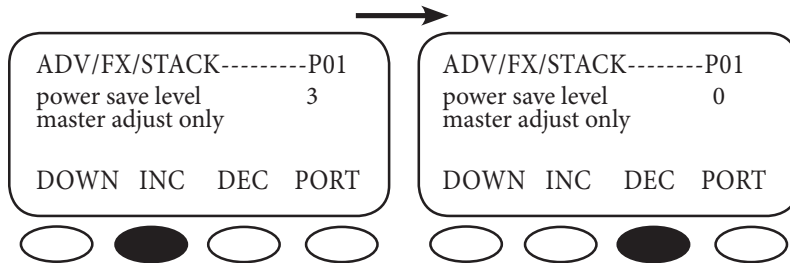

Press the **<INC>** soft key once to adjust the *power save level master adjust only* to 3 and watch the 3rd Slave's "INVERTER" LED turn on. If the system has more than three Slaves, keep increasing the value in the *power save level master adjust only* screen and verify that each Slave's "INVERTER" LED comes on as expected. This check verifies all FXs are stacked correctly.

Adjust the *power save level master adjust only* to 0 by pressing the **<DEC>** soft key.

### 3-Phase Stacking (Three FX Series Inverter/Chargers Only)

A 3-phase stacked system with only three FXs must be set up as described here:

- Turn off all AC output and AC input breakers before powering up FXs.
- Plug the top FX into Port 01 of the HUB, the 2nd FX into Port 02, and the 3rd FX into Port 03.
- Change the HUB jumper for 3-phase stacking (refer to the HUB manual).
- Go to the first MATE stacking menu (*Stack Phase*) press the **<PORT>** soft key until Port 01 appears.
- Set the *Stack Phase* of the Port 01 FX to *3ph Master* by pressing the **<INC>** soft key. The Master FX is considered phase A.
- Press the **<PORT>** soft key and verify P02 (2nd FX) displays.
- Press the **<INC>** soft key five times to set the *Stack Phase* to *3ph Slave*. The P02 FX is now set as phase B, producing 400VAC between itself and the Master (P01).
- Press the **<PORT>** soft key again and verify P03 (3rd FX) is displayed.
- Push the **<INC>** soft key five times to set the *Stack Phase* to *3ph Slave*. This FX (P03) is now set as phase C, producing 400VAC between itself and the master (P01) and also 400VAC between itself and the FX on phase B.

**NOTE:** The AC input to a 3-phase system must be a 3-phase source (generator or grid).

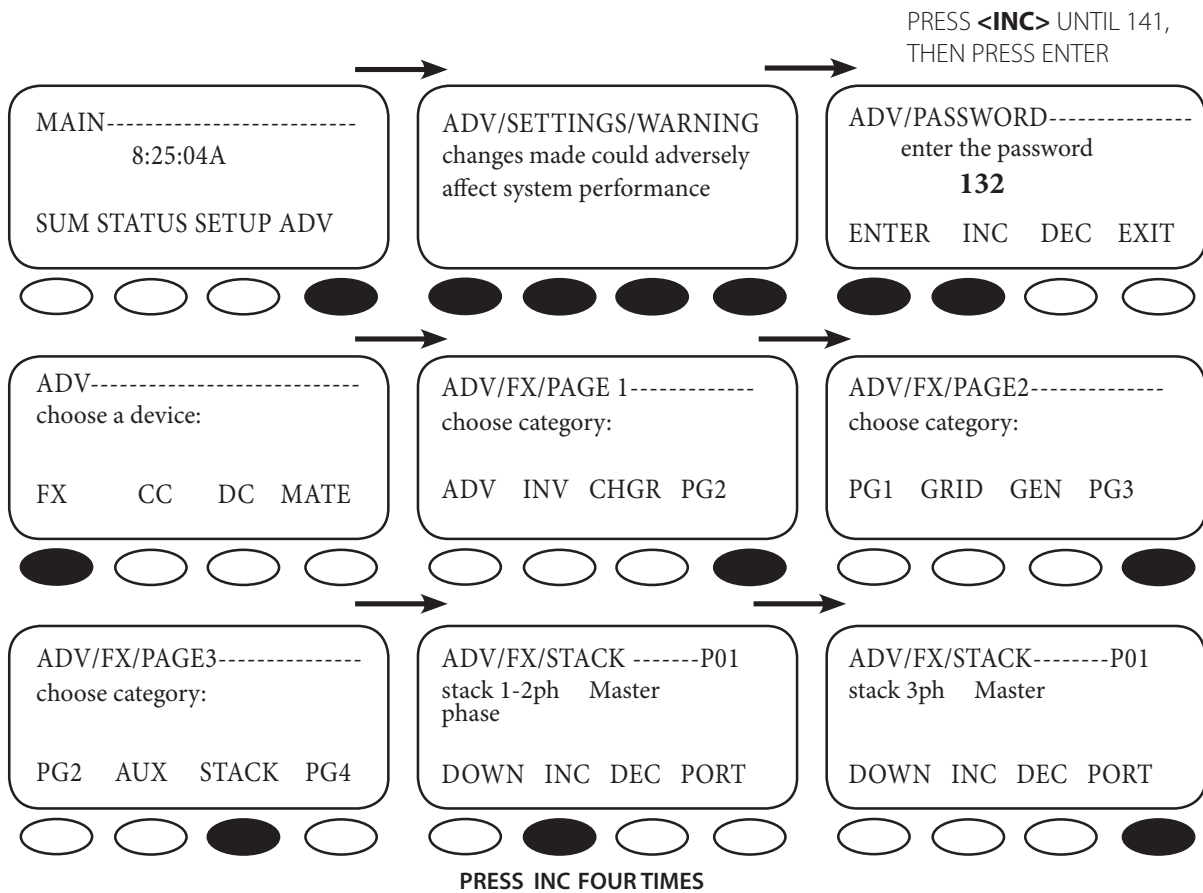



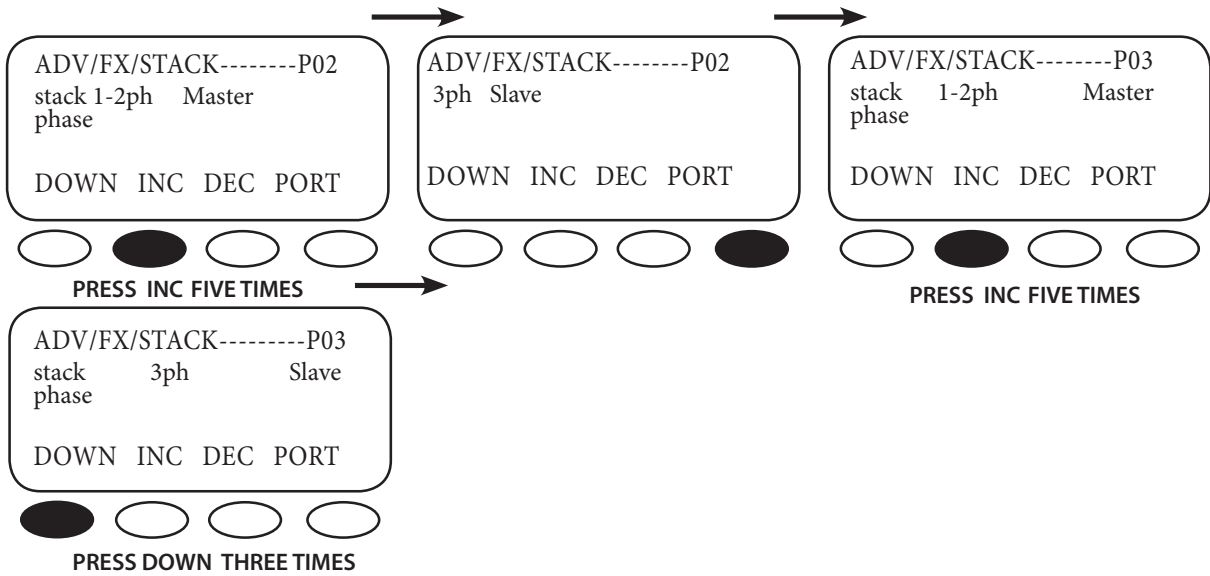

## AUXILIARY (AUX) FUNCTIONS

The AUX output provides a 12VDC, 0.7ADC max output at the AUX terminals to control DC or AC external loads. Typical loads include signaling a generator system to start, sending a fault alarm signal, or running a small fan to cool the FX.

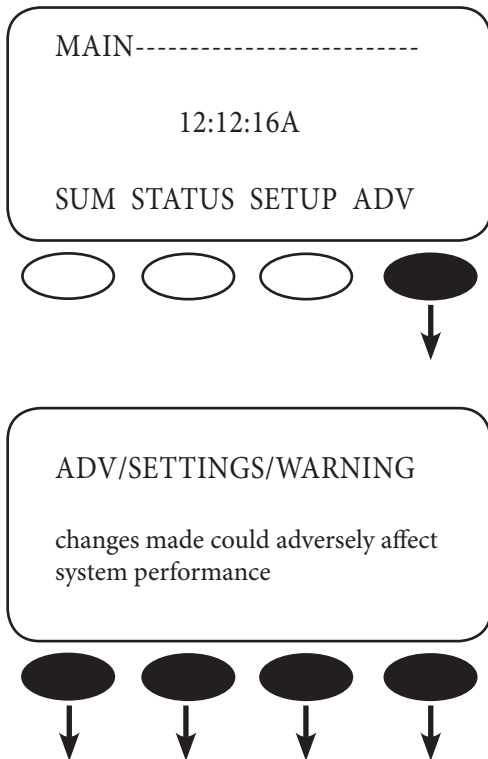

Press the **<ADV>** soft key.

**NOTE:** Pressing and holding the first two soft keys at the same time will always bring up the Main Menu screen.

Push any soft key on the ADV/SETTINGS/WARNING screen and go to the ADV/PASSWORD screen.

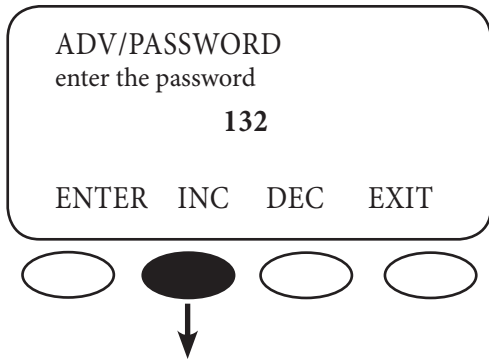

The screen displays **<132>**. Press the **<INC>** soft key until it scrolls to the password 141.

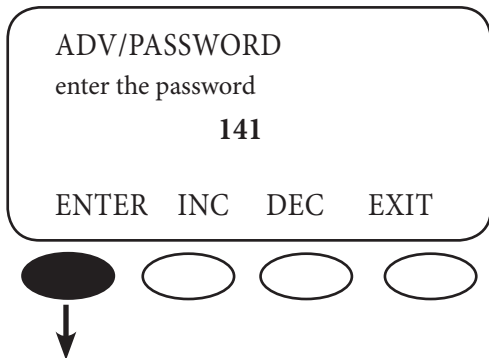

Push the **<ENTER>** soft key.

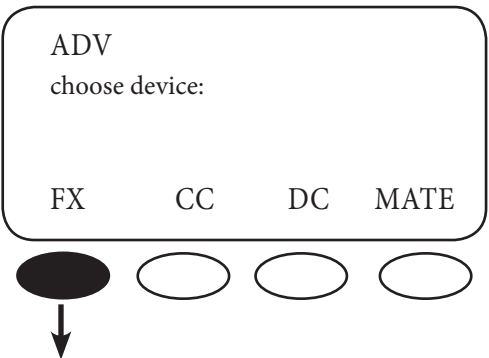

In the ADV menu, press the **<FX>** soft key.

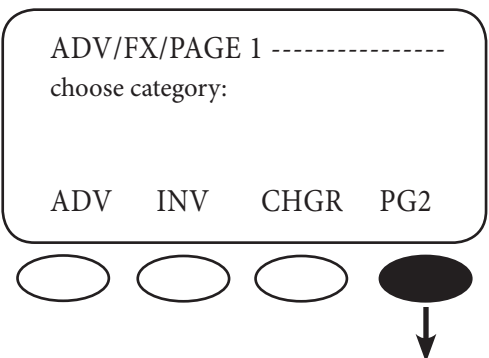

On the ADV/FX/PAGE 1 screen, press the **<PG2>** soft key and go to the ADV/FX/PAGE2 screen.

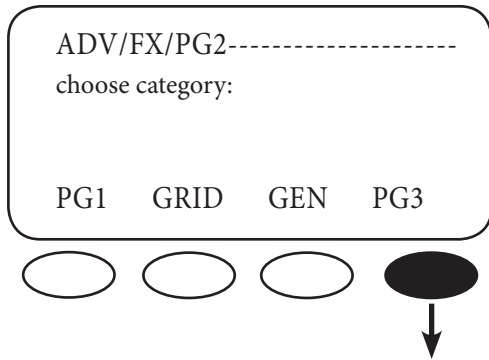

Press the **<PG3>** soft key which leads to the ADV/FX/PAGE3 screen.

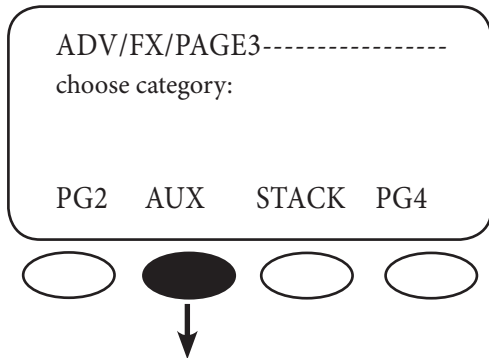

On the ADV/FX/PAGE3 screen, press the **<AUX>** soft key to adjust the AUX output set points and operation.

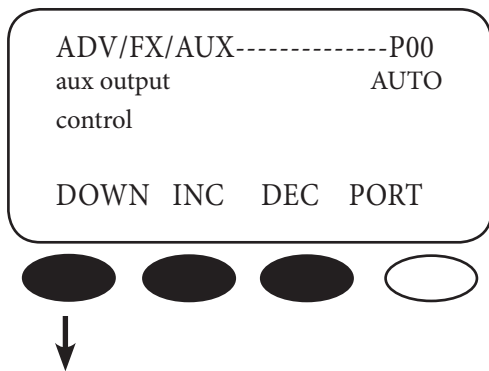

Selecting the **<INC>** or **<DEC>** soft keys changes the mode of the AUX.

- AUTO allows the AUX to perform a selected AUX OUTPUT FUNCTION, determined in the following screens.
- OFF disables the AUX.
- ON activates the AUX regardless of the selected function.

Press the **<DOWN>** soft key to select on an AUX OUTPUT FUNCTION

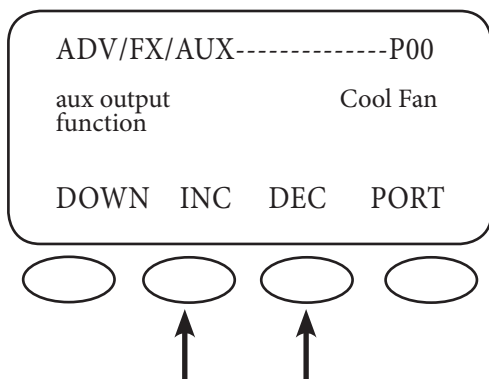

Pressing the **<INC>** or **<DEC>** soft keys changes the stacking phase.

There are nine AUX OUTPUT FUNCTIONS:

- Cool Fan
- Divert DC
- Divert AC
- AC Drop
- Vent Fan
- Fault
- GenAlert
- Load Shed
- Remote

Pressing either the **<INC>** or **<DEC>** soft key will bring up another AUX OUTPUT FUNCTION.

## LIST OF AUX FUNCTIONS

- **Cool Fan** activates the standard TurboFan which cools the FX during an over temperature condition.
- **Divert DC** and **Divert AC** allows the AUX to divert excess renewable energy to a DC or AC load, respectively. This allows control of energy sources such as wind turbines or hydro-generators. When using Divert AC, the AUX output will shut off if the inverter is overloaded.
- **AC Drop** is activated when an AC power source disconnects from an FX. An indicator, such as an alarm, connected to the AUX warns a user that AC power is no longer available.
- **Vent Fan** provides 0.7 amps to run a 12VDC fan for removing hydrogen from the battery compartment. Vent Fan can operate automatically when the *VENTFAN ON* voltage set point is exceeded or it can operate intermittently by adjusting the *VENTFAN OFF PERIOD*.
- In **Fault** mode, the AUX can send an alarm signal via radio, pager, or telephone device when the FX enters into an error condition. Fault mode can also be used to log error conditions by triggering an event recording device.
- **GenAlert**, through a 12VDC relay, will tell the system to start a two-wire type generator when the battery voltage falls below a certain set point. GenAlert can be adjusted according to the short fall battery voltage, the amount of time spent at this voltage, the recharged voltage and amount of time at this voltage before GenAlert is de-energized.
- **Load Shed** energizes the AUX the reduce the load demand on the batteries and the inverter function, thus acting as a load management system.
- Setting the AUX to **Remote** allows a message sent through the serial Port on the MATE to switch the AUX on and off.

**NOTE:** that using Advanced Generator Start (AGS) overrides any programmed AUX function.

## ADJUSTABLE AUX OUTPUT FUNCTIONS

There are four AUX functions whose settings can be adjusted by the user:

- Diversion
- Vent Fan
- GenAlert
- Load Shed

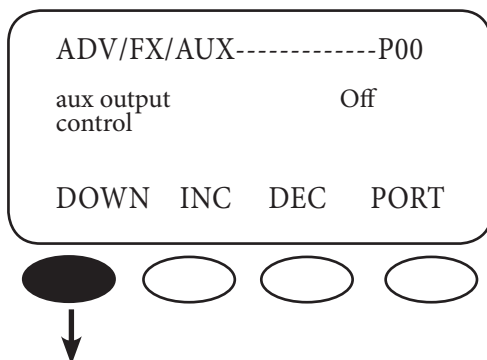

From the *aux output control* screen, press the **<DOWN>** soft key

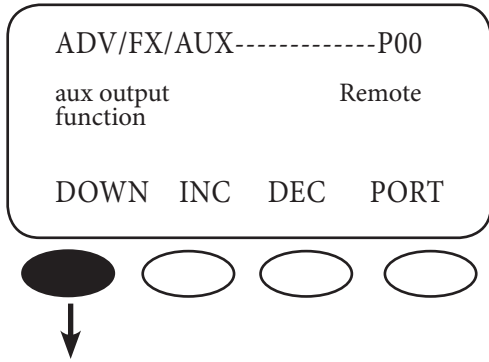

From the *Remote aux output function* screen, press the **<DOWN>** soft key. This will bring up the first of several screen used to adjust which ever mode you have chosen for the AUX function.

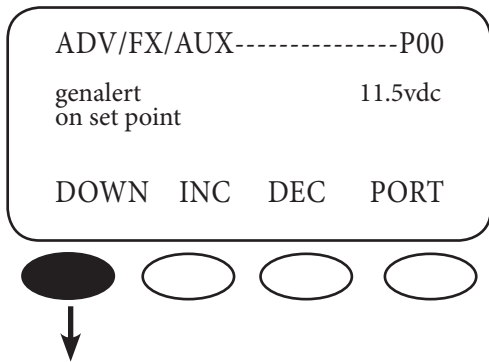

The *genalert on set point* screen shows the voltage--whose range is between 10.0VDC and 14.0VDC, adjusted with the **<INC>** and **<DEC>** soft keys--at which the AUX is energized in *genalert* mode. Press the **<DOWN>** soft key to view the *genalert on delay* screen.

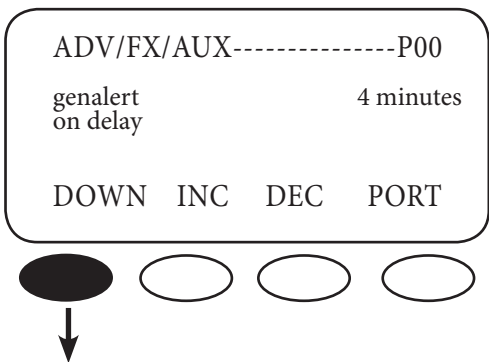

The *genalert on delay* is the amount of time the battery voltage must remain below the *genalert set point* before the AUX is energized. This allows for brief periods of heavy load usage and has a range of 0-240 minutes in one minute increments, adjustable with the **<INC>** and **<DEC>** soft keys. Press the **<DOWN>** soft key to bring up the *genalert off set point* screen.

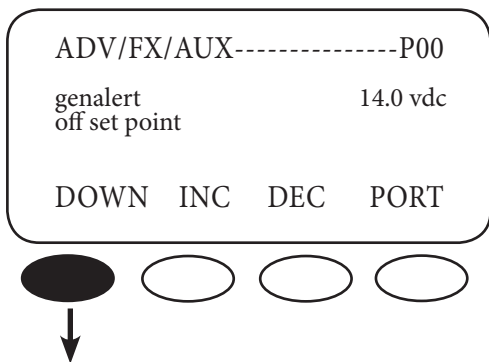

In *genalert* mode, the AUX de-energizes when the *genalert off set point* is reached. This set point's range is between 12.0VDC and 18.0VDC and is adjusted in 0.1 VDC increments using the **<INC>** and **<DEC>** soft keys. Press the **<DOWN>** soft key to view the *genalert off delay* screen.

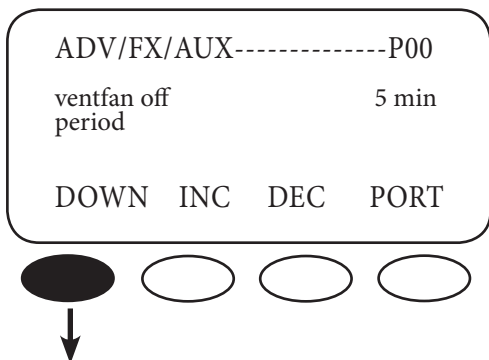
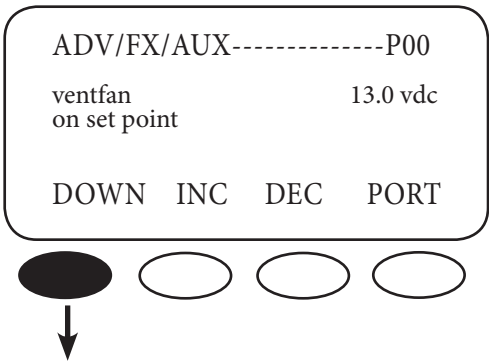
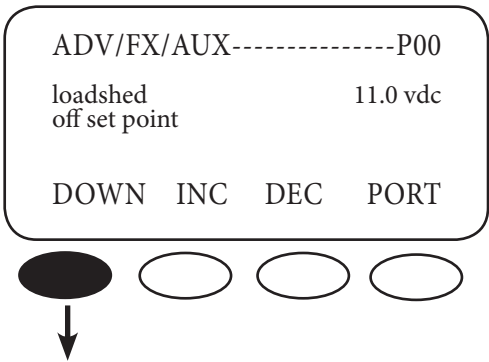
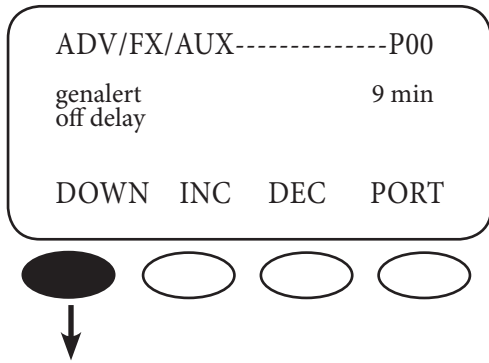

After a battery has recharged or returned to the *genalert off set point*, *genalert off delay* determines the amount of time the generator remains on to assure the battery has been more fully recharged. The user can adjust this time from 0-240 minutes in using the **<INC>** and **<DEC>** soft keys. Press the **<DOWN>** soft key to view the *loadshed off set point* screen.

The *loadshed off set point* is the battery voltage which triggers the AUX to reduce the inverter and battery loads. When the battery voltage drops below this value for three seconds, the AUX powers a DC coil relay to disconnect an AC load. Once triggered, *loadshed* remains on for at least three minutes. The *loadshed off set point* is adjustable from 10 VDC-14VDC using the **<INC>** and **<DEC>** soft keys. Press the **<DOWN>** soft key to bring up the *ventfan on set point*.

Recharging causes batteries to emit mostly hydrogen gas. When the AUX is set to *ventfan*, a fan ventilates a battery enclosure. The *ventfan on set point* establishes the battery voltage which energizes the AUX and thus the fan for a one minute period. The voltage setting has a range of 10.0VDC-16.0VDC in 0.1 VDC increments using the **<INC>** and **<DEC>** soft keys. Press the **<DOWN>** soft key to view the *ventfan off period* screen.

If a ventilation fan is only needed intermittently, the *ventfan off period* shuts the fan off for a user-determined time before starting up again for a one-minute period when the battery voltage exceeds the *ventfan on set point*. This *off period* can be set from 0-30 minutes using the **<INC>** and **<DEC>** soft keys. Setting this period to zero will keep the fan running the entire time the battery voltage is high enough to activate the *ventfan* function. Setting it to five minutes means the fan will run for one minute and then shut off for five minutes until the battery voltage drops and the fan is no longer needed. Press the **<DOWN>** soft key to view the *diversion on set point* screen.

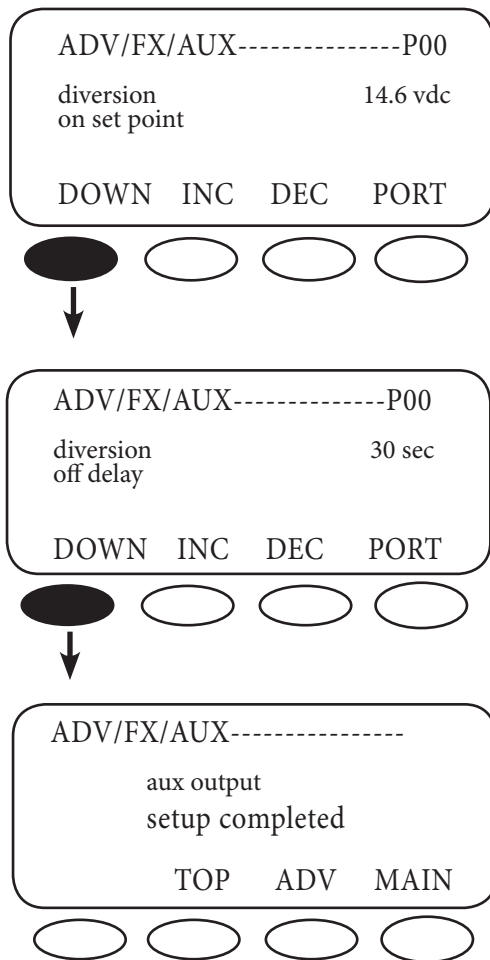

After deciding on Divert DC or Divert AC in the AUX output function screen, use the *diversion on set point* screen to choose the voltage which will activate this function. This value can range from 12.0VDC-16.0VDC and can be adjusted in 0.1 VDC increments using the **<INC>** and **<DEC>** soft keys. Press the **<DOWN>** soft key to view the *diversion off delay* screen.

The *diversion off relay* determines how long the AUX will be energized after the battery voltage which caused the diversion falls below the diversion on set point. This relay can range from 0-240 seconds in one-second increments as adjusted with the **<INC>** and **<DEC>** soft keys. Press the **<DOWN>** soft key to view the final *aux output setup completed* screen.

## BATTERY CHARGING

Keeping your battery bank energized is very important. Although a battery bank can last for many years if properly cared for, it can also be ruined in a short period of time if neglected.

### Battery Charging Set Points

To preserve your batteries, always follow your battery manufacturer’s recommendations using the following information:

- Absorb Voltage
- Float Voltage
- Equalize Voltage
- Recommended Depth of Discharge (DOD)

Absorb, Float and Equalize voltage set points are programmed using the OutBack MATE.

## MAINTENANCE

Please contact OutBack Power Systems Technical Services for any FX repairs due to malfunctions or damage.

For routine, user-approved maintenance:

- Disconnect all circuit breakers and related electrical connections before doing any cleaning or adjustments.
- Solar modules may produce hazardous voltages when exposed to light; cover them with opaque material before servicing any connected equipment.
- If a remote or automatic generator start system is used, disable the automatic starting circuit and/or disconnect the generator from its starting battery while servicing it to prevent starting while servicing.

# BATTERY CHARGING INSTRUCTIONS

## Battery Charging Set Points

Recharging set points are programmed using the OutBack MATE in the ADV/FX/CHARGER screens. The MATE comes set with default charging values found in the CHARGER menu (see page 13). These values might not be the best for your specific batteries and can result in uneven recharging. To preserve your batteries, always follow your battery manufacturer's recommendations using the following information:

- Absorb Voltage\* • Float Voltage • Equalize Voltage\*\* • Recommended Depth of Discharge (DOD)

\*For longer generator life and a shorter *absorb time period*, OutBack recommends using the manufacturer's maximum absorb voltage.

\*\* Batteries should not be discharged over 50%. Flooded lead-acid should be equalized, or fully charged, every 1-6 months depending on their use in order to maintain full recharging capability. Sealed batteries are not equalized (refer to manufacturer's instructions). Equalizing is done using the MATE at user selected intervals; it is not an automatic function.

## Battery Charging Sequence

The FX connects to an AC source in 30 seconds (default setting). The AC voltage passes through the FX AC transfer switch and then (1) powers any AC loads connected to the FX AC output terminals and (2) begins a battery charging sequence.

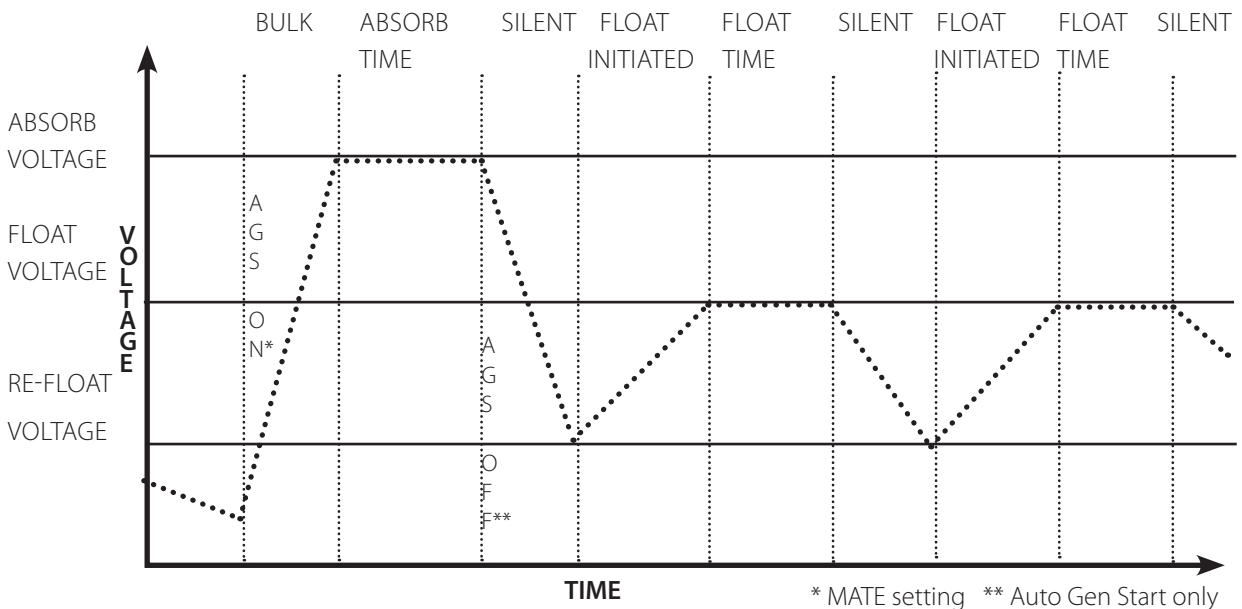

**NOTE:** When the optional Remote Temperature Sensore (RTS) is used, the ABSORB, FLOAT, and EQUALIZE set points are temperature compensated; the REFLOAT voltage, generator-start set points and low-battery voltage initializations are not.



## Battery Charging Sequence

### 1. BULK

- FX uses as much AC current as possible to raise the battery voltage to ABSORB (time period for BULK charging varies) voltage level.

### 2. ABSORB

- FX uses as much AC as necessary to maintain the ABSORB voltage for the ABSORB TIME (default is one hour), decreasing the AC current as the ABSORB charge continues.

### 3. SILENT

- The first SILENT mode follows ABSORB. During this time, the FX charging operation stops, but continues monitoring the battery voltage.

**NOTE:** If a generator has automatically started during a low-voltage condition using AGS (please see the MATE manual), the FX will shut it off after the ABSORB TIME period.

### 4. REFLOAT

- If a generator has been manually started or a utility grid is connected, the FX allows the battery voltage to drop to the REFLOAT voltage and then begins a FLOAT charge.

### 5. FLOAT

- During the FLOAT stage, the battery voltage rises to the FLOAT SET POINT for the FLOAT TIME LIMIT. The FLOAT stage is intended to maintain batteries with connected DC loads. If there are no DC loads, the battery voltage will usually remain above the REFLOAT voltage set point.

### 6. SILENT

- After the FLOAT TIME LIMIT (default is one hour), the FX returns to SILENT mode until the battery voltage drops to its REFLOAT voltage again. The FX then repeats the FLOAT charge for the FLOAT TIME period. The FX will continue this SILENT, REFLOAT, and FLOAT cycle until the AC source is disconnected.

## Charging Constraints

- *Rated Continuous AC Generator Current:* Using the MATE, a user can set the AC/2 GEN LIMIT, which is the maximum continuous AC generator current (at 230VAC). When the combined AC current used by the FX's charger and the loads connected to the FX's AC output exceed the AC/2 GEN LIMIT, the FX will reduce the AC current used by the charger to ensure the generator does not overload.
- *Low AC Input Voltage:* The FX has minimum and maximum voltage settings for the AC input source to ensure downstream loads are not damaged by high or low voltage. If the FX is charging and passing AC through, the voltage can be dragged down to the FX's LOW VOLTAGE LIMIT. If this occurs, the FX reduces the charger to sustain an acceptable charge. If the FX goes below the LOW VOLTAGE LIMIT, it will disconnect the AC input source and cease charging.

**NOTE:** Some generators can be adjusted to raise their low voltage settings.

- *External DUMP LOAD is Limiting Battery Voltage:* Wind turbines and micro-hydro systems can produce very high voltages depending on wind and water velocity. These voltages can damage batteries. Battery-determined DUMP LOADS bleed off this excess voltage. The DUMP voltage can be below the target voltage (ABSORB, FLOAT, or EQUALIZE) the FX is trying to reach, preventing the FX from reaching these voltage set points. The FX will continue to charge while the DUMP load continues to absorb voltage. This wastes both generator and grid power. To prevent this, reduce the FX's target voltage to slightly below the DUMP voltage or raise the DUMP voltage to just above the FX's target voltage (this value should be such that it does not overcharge the batteries).
- *AC Input Voltage is Different on AC Input Legs:* In split phase and three phase systems, there are often slightly different voltages present on each leg. This is more likely to occur with generator-supplied AC. If one leg's AC voltage is reduced to its FX's AC LOW VOLTAGE LIMIT, that FX will reduce its charging current so it will not disconnect from the AC input source. The remaining FXs on other AC input legs will not reduce their charging rates unless they also reach a LOW VOLTAGE LIMIT situation.
- *Temperature Limit is Reached:* If an FX becomes too hot to operate properly, it will back off the charger until the temperature drops to a safer level. An FX that is very hot to the touch and charging less vigorously than usual is operating properly.
- *Battery Voltage Target is Reached:* A single FX will back off its charging operation when it reaches its target ABSORB, FLOAT, or EQUALIZE voltage. In a multiple FX system, the SLAVE FXs will back off first, leaving the MASTER to finish the charging.

**FX Default Values (subject to change with FX upgrades)**

Correction Factor
• 24VDC: Multiply 12VDC values by 2
• 32VDC: Multiply 12VDC values by 2.64
• 48VDC: Multiply 12VDC values by 4

12 VDC System	DEFAULT	MINIMUM	MAXIMUM
Float Voltage	13.6V	12V	15V
Absorb Voltage	14.4V	13V	16V
EQ Voltage	14.4V	14V	17V
ReFloat	12.5V	11V	13V
LBCO	10.5V	9V	12V
LBCI	12.5V	10V	14V
Sell RE	13V	10V	15V
<b>Gen Alert</b>			
Off Set Point	14V	12V	18V
On Set Point	11V	10V	14V
Load Shed Off Set Point	11V	10V	14V
Vent Fan ON Set Point	13V	10V	16V
Diversion ON Set Point	14.6V	12V	16V
Absorb Time	1.0 hours	0.0 hours	24.0 hours
EQ Time	1.0 hours	0.0 hours	24.0 hours
Float Time	1.0 hours	0.0 hours	24.0 hours
AC2/Gen Transfer Delay (Cycles for AC)	60 cycles* (*20 for Grid-Tie)	0 cycles	240 cycles
Search	6	0	50
Grid Lower Limit	207V	80V	220V
Grid Upper Limit	270V	250V	300V
Grid Connect Delay	.5 min	.2 min	15.0 min
DROP or USE	USE	N/A	N/A
Charger OFF/AUTO/ON	AUTO		
AUX Output Option	COOL FAN		
Gen Alert ON Delay	4 min	0 min	240 min
Gen Alert OFF Delay	9 min	0 min	240 min
Vent Fan OFF Delay	5 min	0 min	30 min
Gen Window Lower Limit	208V	80V	220V
Gen Upper Window Limit	270V	250V	300V
AC1/Grid Transfer Delay (Cycles of AC)	6	0	240
Set AUX Control	AUTO		
Search Pulses	8	2	20
Search Pulse Spacing (Cycles AC)	60	4	120
Stacking Phase	1 or 2 phase		
InPut Select	Master Gen		
<b>Charge Rates</b>			
Vented 24 & 48 VDC	9 AAC	0 AAC	10 AAC
Vented 12 VDC	6 AAC	0 AAC	7 AAC
Sealed 24 & 48 VDC	5 AAC	0 AAC	7 AAC
Sealed 12 VDC	5 AAC	0 AAC	6 AAC
<b>Grid Input Settings</b>			
Set AC Input Size	28 Amp	5 Amp	30 Amp
<b>Gen Input Settings</b>			
Set VAC	230V	210V	240V



## **TWO YEAR LIMITED WARRANTY INFORMATION**

### FX Series Inverter/Charger Products

OutBack Power Systems, Inc. ("OutBack") provides a two year (2) limited warranty ("Warranty") against defects in materials and workmanship for its FX/VFX Series Inverter/Charger products ("Product(s)") if installed in fixed location applications.

The term of this Warranty begins on the Product(s) date of manufacture or the initial purchase date as indicated on the warranty registration card submitted to OutBack, whichever is greater. This Warranty applies to the original OutBack Product(s) purchaser, and is transferable only if the Product(s) remains installed in the original use location. The warranty does not apply to any Product(s) or Product(s) part that has been modified or damaged by the following:

- Installation or Removal;
- Alteration or Disassembly;
- Normal Wear and Tear;
- Accident or Abuse;
- Corrosion;
- Lightning;
- Repair or service provided by an unauthorized repair facility;
- Operation contrary to manufacturer product instructions;
- Fire, Floods or Acts of God;
- Shipping or Transportation;
- Incidental or consequential damage caused by other components of the power system;
- Any product whose serial number has been altered, defaced or removed; or
- Any other event not foreseeable by OutBack.

OutBack's liability for any defective Product(s), or any Product(s) part, shall be limited to the repair or replacement of the Product(s), at OutBack's discretion. OutBack does not warrant or guarantee workmanship performed by any person or firm installing its Product(s). This Warranty does not cover the costs of installation, removal, shipping (except as described below), or reinstallation of Product(s).

To request warranty service, you must contact OutBack Technical Services at 360.435.6030 (North America), +34.93.654.9568 (Europe), or support@outbackpower.com within the effective warranty period. OutBack Technical Support will attempt to troubleshoot the product and validate that the failure is product related. If warranty service is required, OutBack will issue a Return Material Authorization (RMA) number. A request for an RMA number requires all of the following information:

1. Proof-of-purchase in the form of a copy of the original Product(s) purchase invoice or receipt confirming the Product(s) model number and serial number;
2. Description of the problem; and
3. Shipping address for the repaired or replacement equipment.

After receiving the RMA number, pack the Product(s) authorized for return, along with a copy of the original purchase invoice, in the original Product(s) shipping container(s) or packaging providing equivalent protection and mark the outside clearly with the RMA number. The sender must prepay all shipping charges to the agreed upon OutBack Power Systems location, and insure the shipment, or accept the risk of loss or damage during shipment. OutBack is not responsible for shipping damage caused by improperly packaged Products, the repairs this damage might require, or the costs of these repairs. If, upon receipt of the Product(s), OutBack determines the Product(s) is defective and that the defect is covered under the terms of this Warranty, OutBack will then and only then ship a repaired or replacement Product(s) to the purchaser freight prepaid, non-expedited, using a carrier of OutBack's choice, where applicable.

The warranty period of any repaired or replacement Product is twelve (12) months from the date of shipment from OutBack, or the remainder of the initial warranty term, which ever is greater.

THIS LIMITED WARRANTY IS THE EXCLUSIVE WARRANTY APPLICABLE TO OUTBACK PRODUCTS. OUTBACK EXPRESSLY DISCLAIMS ANY OTHER EXPRESS OR IMPLIED WARRANTIES OF ITS PRODUCTS, INCLUDING BUT NOT LIMITED TO ANY IMPLIED WARRANTIES OF MERCHANTABILITY OR FITNESS FOR A PARTICULAR PURPOSE. OUTBACK ALSO EXPRESSLY LIMITS ITS LIABILITY IN THE EVENT OF A PRODUCT DEFECT TO REPAIR OR REPLACEMENT IN ACCORDANCE WITH THE TERMS OF THIS LIMITED WARRANTY AND EXCLUDES ALL LIABILITY FOR INCIDENTAL OR CONSEQUENTIAL DAMAGES, INCLUDING WITHOUT LIMITATION ANY LIABILITY FOR PRODUCTS NOT BEING AVAILABLE FOR USE OR LOST REVENUES OR PROFITS, EVEN IF IT IS MADE AWARE OF SUCH POTENTIAL DAMAGES. SOME STATES (OR JURISDICTIONS) MAY NOT ALLOW THE EXCLUSION OR LIMITATION OF WARRANTIES OR DAMAGES, SO THE ABOVE EXCLUSIONS OR LIMITATIONS MAY NOT APPLY TO YOU.



## LIMITED WARRANTY REGISTRATION

Complete this form to request a Limited Warranty,  
and return it to:

Outback Power Systems Inc.  
19009 62nd Ave. NE  
Arlington, WA 98223

NOTE: Please submit a copy (not the original) of the Product purchase invoice, which confirms the date and location of purchase, the price paid, and the Product Model and Serial Number.

### Two Year Limited FX Warranty Registration

#### System Owner

Name: \_\_\_\_\_ Country: \_\_\_\_\_  
Address: \_\_\_\_\_ Telephone Number: \_\_\_\_\_  
City, State, Zip Code: \_\_\_\_\_ E-mail: \_\_\_\_\_

#### Product

Product(s) Model Number(s): \_\_\_\_\_ Sold by: \_\_\_\_\_  
Product(s) Serial Number(s): \_\_\_\_\_ Purchase Date: \_\_\_\_\_

Please circle the three most important factors affecting your purchase decision:

- Price
- Product Reputation
- Product Features
- Reputation of OutBack Power Systems
- Value

#### System

System Install/Commission Date: \_\_\_\_\_ Total Nominal System AC Output in KW: \_\_\_\_\_  
Nominal System AC Voltage: \_\_\_\_\_ System Battery Bank Size (Amp Hours): \_\_\_\_\_  
Type of Batteries: \_\_\_\_\_

Are you using a generator with this system? (Circle One): Yes No

If yes, please list the make and model: \_\_\_\_\_

If yes, is the generator's output is (Circle One): AC DC

#### Installer

Name (If Applicable): \_\_\_\_\_ Address: \_\_\_\_\_  
City, State, Zip: \_\_\_\_\_ E-mail: \_\_\_\_\_  
Contractor Number: \_\_\_\_\_

#### \*Extended Warranty

OutBack Power Systems offers an optional three (3) year extension to the standard two (2) year Limited Warranty for the FX/VFX Series Inverter/Charger product. To request a 3-year Limited Warranty extension for a total effective warranty coverage period of five (5) years; include a check or money order in the amount of \$300USD payable to OutBack Power Systems, Inc. along with your Warranty Registration.

Revision.2008-04-01

Revision.2008-04-01





**Corporate Headquarters**  
19009 62nd Avenue NE  
Arlington, WA 98223 USA  
Phone: (+1) 360.435.6030

[www.outbackpower.com](http://www.outbackpower.com)

**European Sales Office**  
C/ Castelló, 17  
08830 - Sant Boi de Llobregat  
BARCELONA, España  
Phone: +34.93.654.9568

900-0084-01-00 REV C